



# GMV5

GREE Multi VRF 5



## GREE ELECTRIC APPLIANCES, INC. OF ZHUHAI

Add: West Jinji Rd, Qianshan, Zhuhai, Guangdong, China 519070  
Tel: (+86-756) 852 2218 Fax: (+86-756) 866 9426  
Email: gree@gree.com.cn Http://www.gree.com

## HONG KONG GREE ELECTRIC APPLIANCES SALES LIMITED

Add: Unit 2612, 26/F., Miramar Tower 132 Nathan Road, TST, Kowloon, HK  
Tel: (852) 3165 8898 Fax: (852) 3165 1029

**Note:**  
Gree is committed to continuously improving its products to ensure the highest quality and reliability standards, and to meet local regulations and market requirements.

All features and specifications are subject to change without prior notice.



All images provided in this catalogue are used for illustration purposes only.  
Copyright© Gree Electric Appliances, Inc. of Zhuhai. All rights reserved.

## GC-1610-01(EU VERSION)



Distributor information



# CONTENTS

01 GMV5E

19 GMV5 Mini & Slim

27 Indoor Units

51 Control System



**GMV5E** DC Inverter Multi VRF System with its high-efficient inverter compressors has four exciting features which are different from those found on traditional inverter air conditioners: excellent energy-saving effect, more reliable and precise operation, smarter network control, providing users with best air conditioning experience.



# GMV5E



## Key Features

### All DC Inverter Technology to Improve Compression Efficiency

All DC inverter compressor and high-performance high pressure chamber are adopted to reduce loss of overheat and improve compression efficiency from direct intake. Compared with low pressure chamber, the compression efficiency is improved. High-efficient permasyon motor is adopted to provide better performance than traditional DC inverter compressor.

### All DC Inverter Compressor

- All DC inverter compressor is used in this system. It can directly intake gas to reduce loss of overheat and improve efficiency.

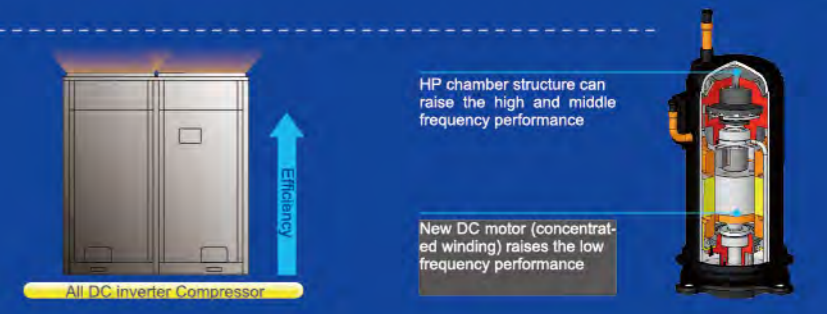

- High-efficient permasyon motor is adopted to provide better performance than traditional DC inverter compressor.

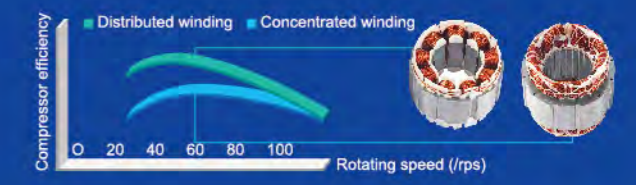

- Technology of Maximum Torque Control with Minimum Current**  
It can reduce energy loss caused by device winding so as to realize higher efficiency.

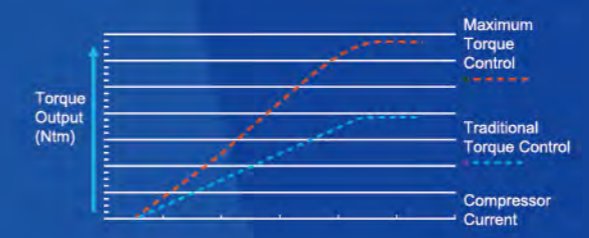

- 180° Sine Wave DC Speed Varying Technology**  
It can satisfy various places' demands for different temperature and is able to save a great deal of electricity and provide users with utmost comfort at the same time.

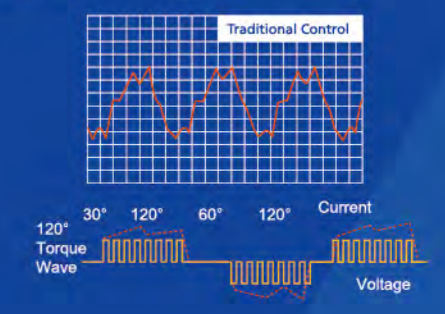

- Low-frequency Torque Control**  
It can directly control motor torque, through which fan motor can run at a low speed. Users will feel more comfortable while requirements of the system are also met.

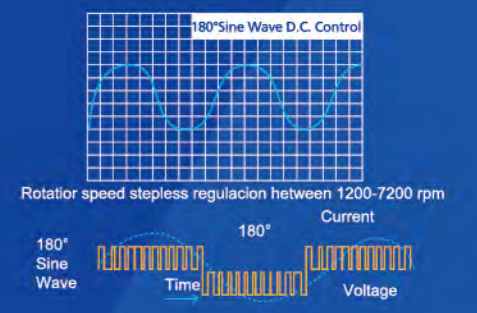

## Sensorless DC Inverter Fan Motor

- Stepless speed regulation ranges from **5Hz** to **65Hz**. Compared with traditional inverter motors, the operation is more energy-saving.

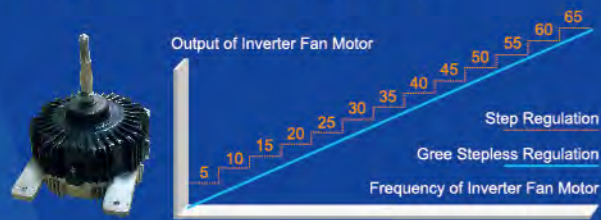

- Sensorless control technology guarantees lower noise, less vibration and steadier operation.

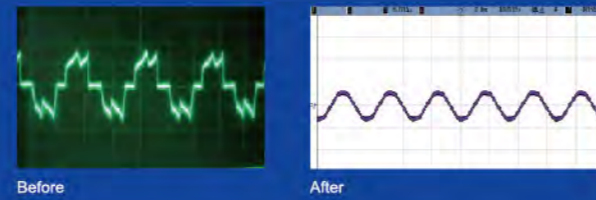

## Compact design

With compact design, the outdoor unit can be carried to the roof of building through elevator, with no need of crane. It is easier for delivery and installation.



## 88HP Max Capacity-The Largest Free Combination

Max capacity of single outdoor unit reaches **22HP** and max combination capacity is even up to **88HP**, in an industry leading level.

Max combination capacity is extended to 88HP



Money is saved in system cost and piping



## Non-polar CAN Technology to Improve Communication Efficiency

- Gree is the first one to adopt non-polar CAN communication technology in the industry. CAN communication technology provides quicker system response speed, more convenient installation debugging and more reliable communication data.

Performance index	Company A Multi-VRF Network	GMV5E DC Inverter CAN Network
Reliability	Software check	Hardware check, more reliable
	One unit's communication error may lead to a breakdown of the whole network	If one unit has errors, it will exit from the network without any influence to other units.
Communication Efficiency	Low utilization	High utilization
	Communication speed is about 10Kbps.	Communication speed is 20Kbps.
Compatibility	One main network, difficult to add new equipment	Multiple main networks, easy to add new equipment.
Communication Distance	1000m	1500m

- The non-polar CAN communication technology is applied to support flexible wiring installation, greatly reducing construction difficulties.



## Wide Range of Voltage and Operation Condition

Working voltage range of GMV5E system has been improved to **320V~460V**, which surpasses the national standard of 342V~420V. For places with unsteady voltage, this system can still be running well.



Outdoor operation temperature range is improved to **-5°C~52°C in cooling** and **-20°C~24°C in heating**.



## Wider Applicable Location

GMV5E can realize a combination of 4 outdoor unit modules connecting with as many as **80** indoor units. It's especially applicable for business building or hotels.



## Refrigerant Storage and Distribution

The GMV5E system is designed without liquid receiver and the excess refrigerant is stored in the piping, which can minimize the refrigerant charging volume and enhance the control accuracy of refrigerant.

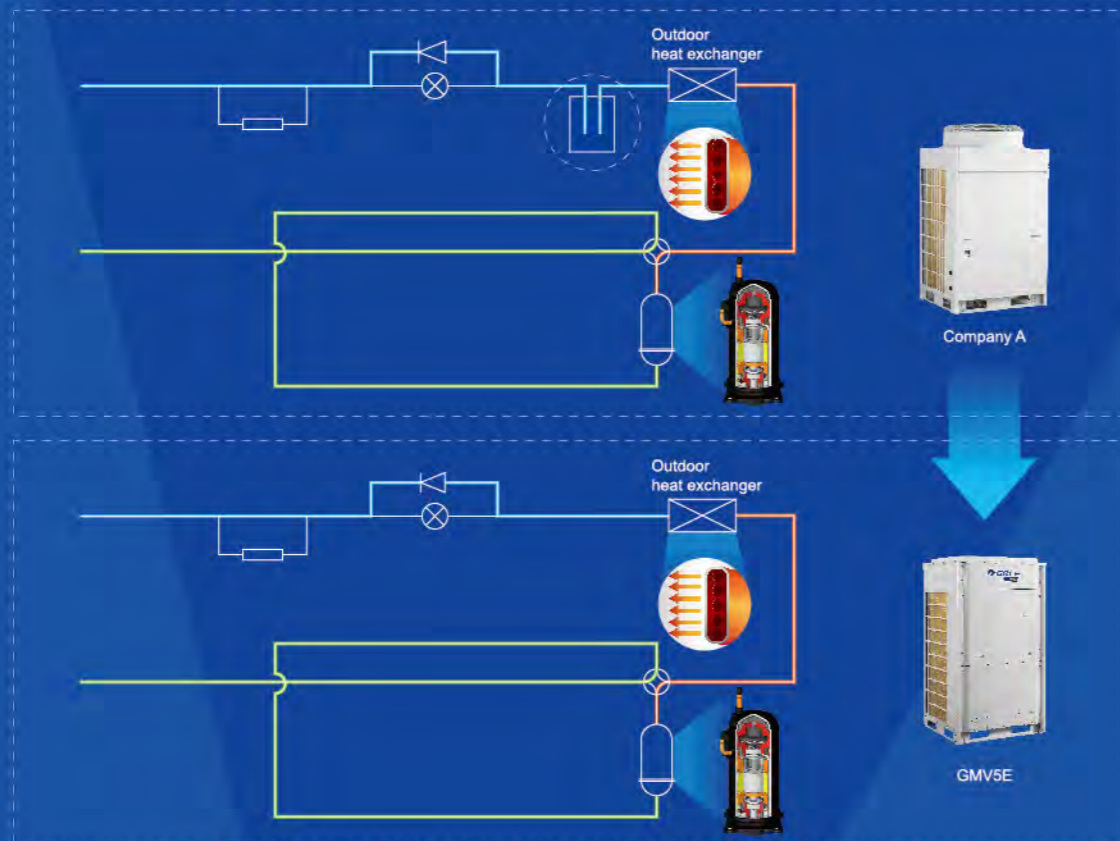

## High Efficiency and More Energy Saving

Thanks to the advanced all DC inverter technology, optimized system design and accurate intelligent control technology, EER of GMV5E is up to 4.73 while COP is up to 5.2.

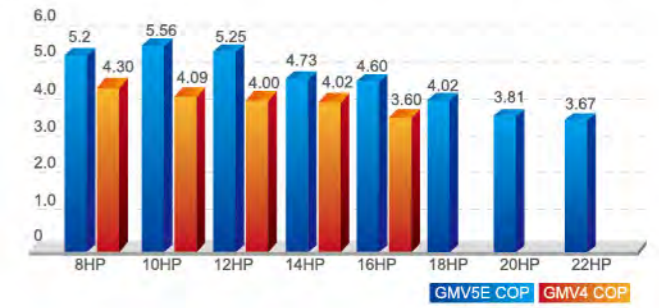

## New Generation of Energy-saving Operation Control Technology with Energy Saving Up to 20%

The GMV5E system has 2 modes for energy saving, which can be chosen to meet different electricity demands.

### Mode 1:

In auto energy-saving mode, the system will self-adjust parameters according to the operation status, thus to lower the cost of electricity. Up to 15% of energy can be saved.

### Mode 2:

In compulsory energy-saving mode, the system will limit power output forcibly. Up to 20% of energy can be saved.

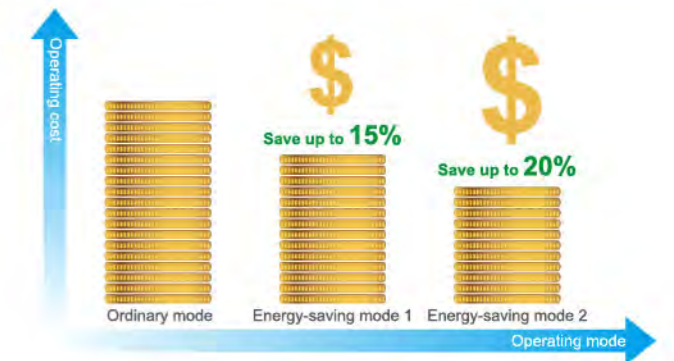

## Intelligent defrosting control

During the heating process, the frost status of the unit will be different after affecting by factors of outdoor ambient temperature, load status and operation time. Through real-time detection of operation parameters of the system, it can decide the defrosting time by intelligently estimating the thickness of frost, high pressure of system and blockage status of heat exchanger.

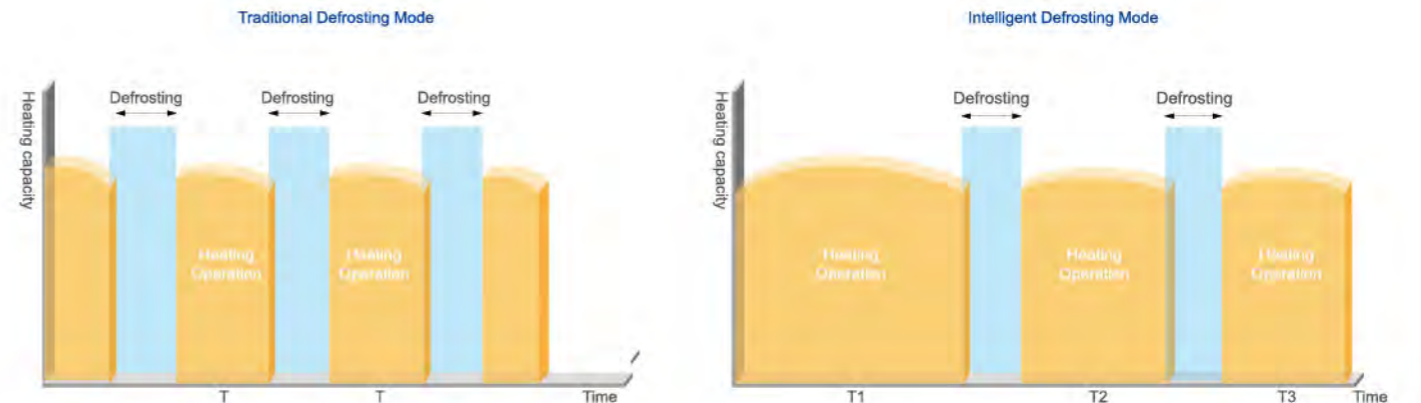

### Accurate Intelligent Allocation Technology of Capacity and Output of Optimal Portion to Ensure Highest Efficiency

- When total load demands more than 75% of a running system's capacity, one more unit will automatically start;
- When total load demands less than 40% of a running system's capacity, one unit will automatically shut down;
- Therefore, each unit shares 40%-75% of the total load.
- Experiments show that an air conditioner costs the least energy when it's operating within 40%-75% of its capacity.

		
Allocation Method	10HP(full load) + 2HP(low load)	6HP(partial load) + 6HP(partial load)
Performance Compared	Unit costs more energy and may be soon damaged.	Unit costs less energy and can always be kept in good condition.

### Output of Optimal Portion to Ensure Highest Efficiency

The best heating or cooling performance can be realized in the most energy-saving way. DC inverter compressor and DC inverter fan will also be operating in this way to ensure high efficiency.



### Sub-cooling Control Technology to Ensure Optimal Cooling and Heating

- Heat exchange loop can control the first subcooling process of heat exchanger. Subcooling degree can reach 11°C.
- Subcooling loop can realize 9°C second subcooling to guarantee cooling and heating performance.

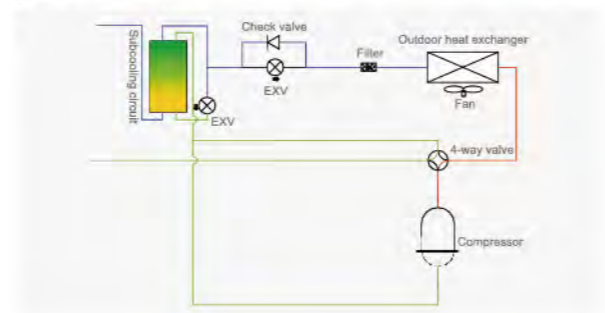
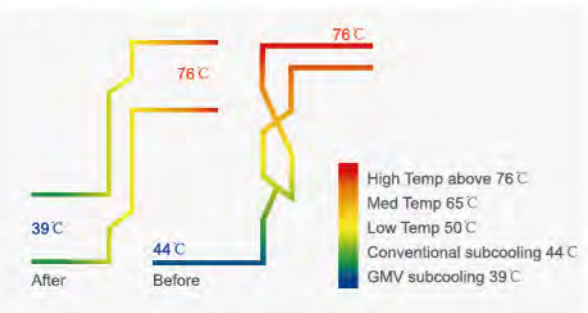

### Temperature Controlled by Wired Controller with Higher Efficiency and More Energy Saving

Through setting temperature lower limit in cooling or dry mode, and setting temperature upper limit in heating, 3D heating or heat supply mode, the system is able to operate in a smaller temperature range so as to achieve energy saving.

### Comfortable Design for A Better Life

The GMV5E system has a wide range of working conditions. Whether it's in a cool winter or a hot summer, normal operation is guaranteed with the least noise, making users feel more comfortable.

### Outdoor Unit Quiet Mode and Quiet Control

- **Quiet at night**  
The system can record the highest outdoor temperature. At night, the system will automatically turn to quiet mode. There are 9 quiet modes which can be set according to actual needs.

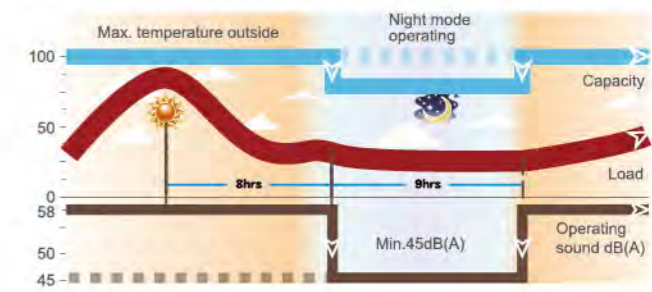

### Quiet in compulsion

The system can also be set in this mode to ensure low noise as long as it is operating. Noise is as low as 45dB(A).



### Quiet Control

1. **Optimized Bossing Design**  
After many times of CFD tests, a new fan bossing structure has been developed to reduce vibration of fan during running. Noise can be reduced by 3dB(A).

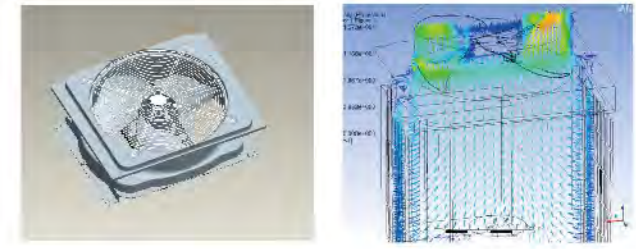

2. **Aerodynamics 3D Axial Fan**  
Compared with conventional fan, it can increase air volume by 12%, improving efficiency as well as lowering noise.



### Quiet Indoor Unit

The indoor unit of the GMV5E system also adopts DC inverter motors to realize stepless regulation. According to indoor temperature or people's needs, users can set this mode through wired controller. Noise is as low as 22dB(A).



### Fast Start-up in Heating

DC Compressor is first started to avoid too much electric current. Inverter compressor can operate in high frequency once starts up, so as to produce more heat.

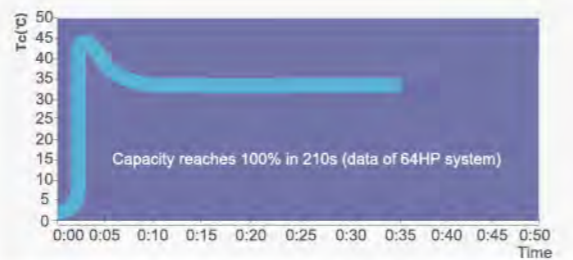

### 7 Speeds Indoor Fan

Indoor fan speed can be set in 7 levels by wired controller. They are auto, low speed, medium-low speed, medium speed, medium-high speed, high speed and turbo. When the wired controller is on, press "FAN" button to set indoor fan speed circularly as below:

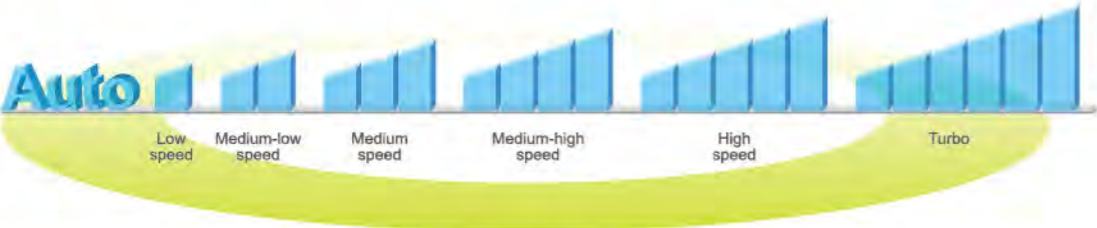

## Excellent Performance Ensured by Advanced Technology

### Two-stage Oil Separation Control Technology (Patented)

First-stage oil separator adopts a filtration expansion valve with separation efficiency of 98%; Second-stage oil separator will separate the remained 2% refrigerant oil with separation efficiency of 95%. General oil separation efficiency reaches 99.9%.

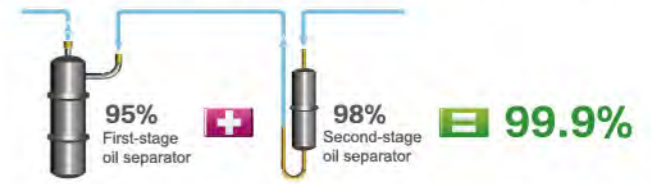

### Oil Return Control Technology

#### New Oil Return Control

Gree new oil return control technology effectively controls system oil return and oil storage status of each compressor, which greatly improves the operation lifespan of compressor.

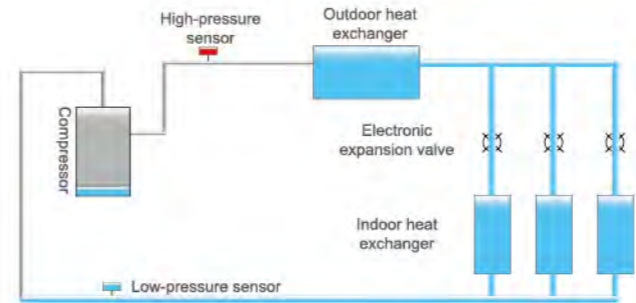

Oil storage status before oil return

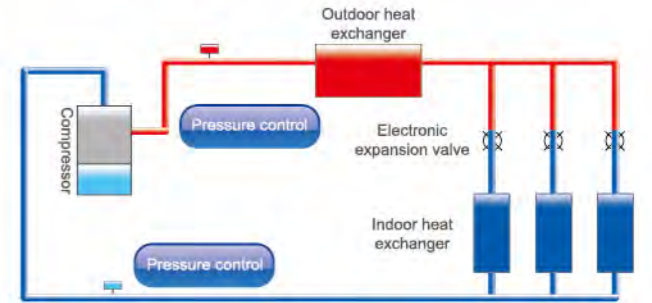

Oil return operation

#### Specialized Compressor Oil Storage Control

The system applies specialized compressor oil storage technology, which can control the lowest oil level for compressor operation.

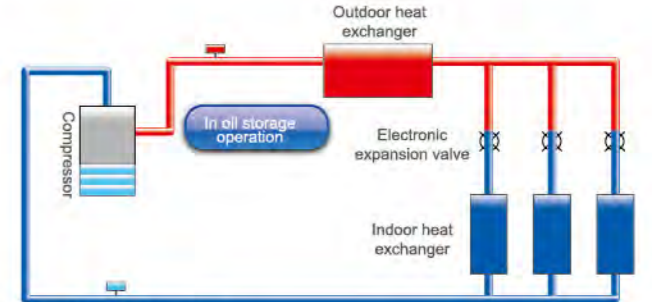

Oil storage operation

### Oil Balance Control Technology

**Oil Balance between Each Module**  
Based on the actual status of each module and compressor, the system can regulate compressor's operation and realize oil balance of each module.

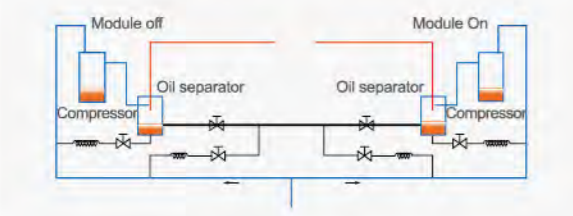

**Oil Balance between Each Compressor**  
Refrigerant is taken into the compressor by the suction pipe and then runs through the cooling system. It can control the oil level and minimum oil volume required by each compressor so as to realize oil balance between each compressor.

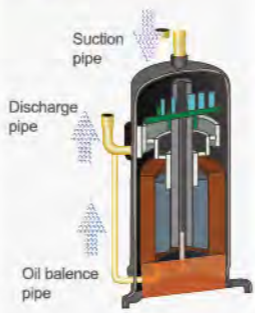

### Intelligent Detection Control

**Pressure Sensor Detection Control**  
Pressure sensor can precisely detect system high pressure and low pressure, and adjust output of fan and compressor, so as to make sure the system can work under the most energy-saving pressure condition.

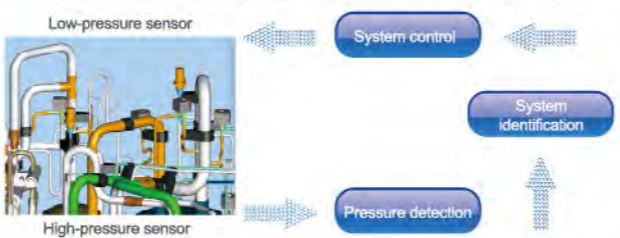

**Temperature Sensor Detection Control**  
Various temperature sensors are equipped to detect ambient temperature, indoor temperature and refrigerant's evaporating temperature, from which the operation status can be measured.

### Multi Electronic Expansion Valves Control

Outdoor electronic expansion valve not only has throttling effect, but also control refrigerant flow. The system adopts multi electronic expansion valves control with total 960 grades regulated by two electronic expansion valves, so as to regulate refrigerant flow precisely and ensures reliable operation of system.

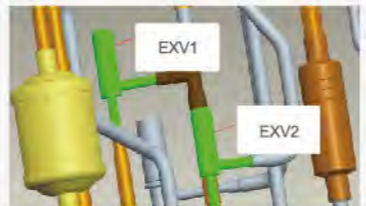

### Smaller Impact to Power Grid

The start-up frequency of inverter compressor is gradually increased from 0Hz to the appointed operation frequency. The start-up current of compressor rotor is decreased by reducing load torque, hence impact to power grid during start-up is reduced and electromagnetic impact to compressor is reduced too.



### Modules Rotation Operating to Maximize Lifespan

**Modules 8h rotation operating**  
The operating priority sequence of the outdoor unit modules will be changed without restart when the system accumulatively operates for 8 hours, which can maximize the service life of the system.



### Highly Anticorrosive Golden Fins

The primary material of Golden Fin is Al-Mn(Aluminum-Manganese) anti-rust alloy, which is coated with the Golden Protection Layer(Components: Epoxy Resin & Modified Acrylic, Silicon free), the anti-corrosive performance in salt-spray testing is 200%~300% higher than normal Blue Fin\*.

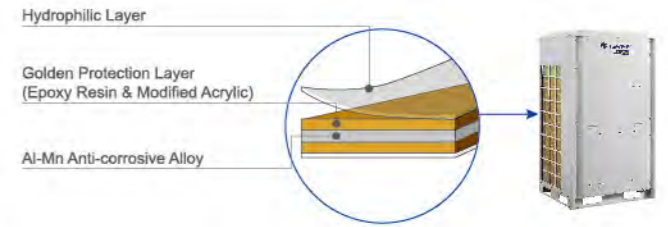

### Emergency Auto-Off Control

The outdoor unit can be linked with a fire alarm signal. In case of emergency, unit can automatically turn off to avoid risk or further loss.



### Lower Power Consumption Operation Mode

As for the area with power consumption limited time period, the maximum power consumption can be set for the operation. Basing on the power consumption of unit and user's requirement, power consumption limitation can be set according to 100%, 90% or 80% of the capacity of complete unit. In this case, user can have more selection at the power consumption limited time period.





### Electricity Shortage Identification

The outdoor unit can receive a power signal of electricity shortage. In some places like first-class hotels, if diesel generator is used temporarily for providing electricity, outdoor unit will send the electricity shortage signal to indoor unit. In this case, only VIP rooms can be provided with air conditioning service.



### Excellent Emergency Operation Function to Ensure Reliable Operation

#### Emergency Function

The GMV5E system can realize a combination of 4 outdoor unit modules. When error is occurred to one of the modules, the others will perform the emergency operation to sustain the air conditioning.



#### Emergency Operation of Compressor

All the compressors in each single module are DC Inverter based, when one compressor has error, others will perform the emergency operation.



#### Emergency Operation of Fan

Double-fan design fan ensures that one fan can still work even if the other one has error.



### SRL (Self-reaction Load) Self-adaptive Control

SRL (Self-reaction Load) can intelligently detect and control system parameters and automatically adapt to indoor cold/heat load requirement to reducing unit's power and improve the energy efficiency.

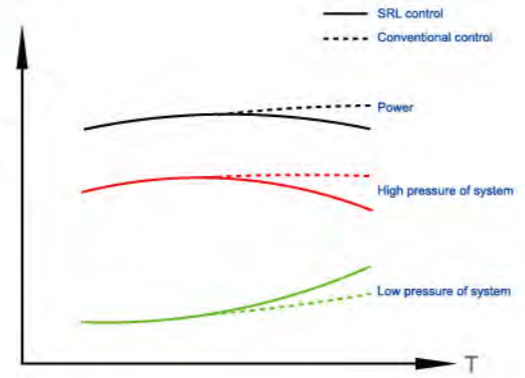

### ODU High Static Pressure Design

System has 4 levels of static pressure that can be set. Up to 82Pa pressure can be set for an outdoor unit. This design is especially useful when an outdoor unit needs to be placed indoor.



### 1000m Pipe Design for Flexible Installation

GMV5E system can be applied in different types of building construction. One of its advantages is the simple pipe design, which will simplify the installation and reduce installation cost.

- Max total pipe length reaches 1000m (with limitation)
- Actual pipe length between the outdoor unit and the farthest indoor unit: 165m
- Max height difference between indoor unit and outdoor unit: 90m

Note:  
a: Distance between the first branch and the farthest indoor unit.  
b: Distance between the first branch and the nearest indoor unit.  
a-b≤40m

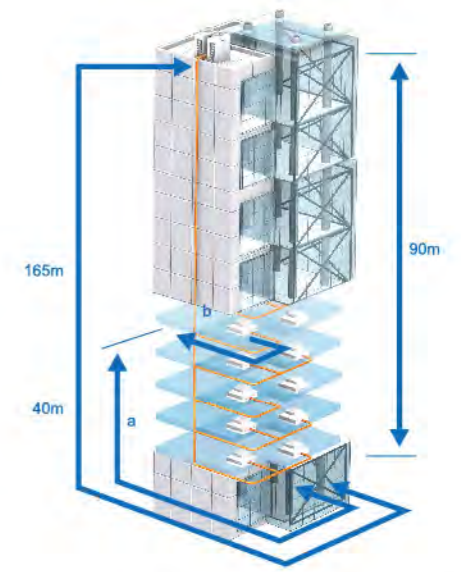

### Engineering Debugging for Convenient Construction

#### 1) GMV5E has five auto debugging features:

- Automatic allocation of IDU and ODU addresses
- Automatic detection of IDU and ODU quantity
- Automatic detection of errors
- Automatic start-up of debugging
- Real-time judgment of pipe errors

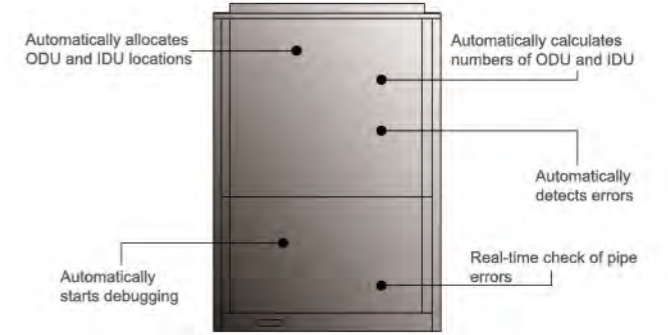

#### 2) Diversified debugging methods for satisfying different requirements and improving debugging efficiency:

- ① Button debugging of outdoor unit
- ② Special GMV debugging system
- ③ CE41-24/F(C) debugger\* has functions of debugging of complete unit, independent debugging of indoor unit, malfunction display, data record and so on. It's no need to connect special software and PC. Moreover, it can connect external USB storage data.

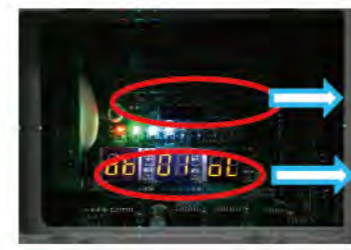

①

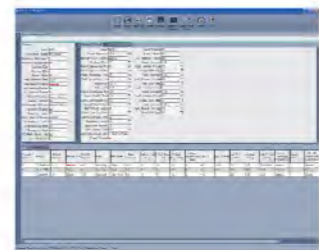

②



③

Note:\* This debugger is under development.

### Auto-refrigerant Recovery for Easy Maintenance

When auto refrigerant recovery function is set and cut-off valve of liquid pipe is closed during maintenance, the system will automatically operate compressor, EXV, solenoid valve and fan, etc. Taking advantage of compressor power, the refrigerant is recovered at the condensing side of outdoor unit to achieve environmental effect. Meanwhile, system low pressure is displayed simultaneously during refrigerant recovery.

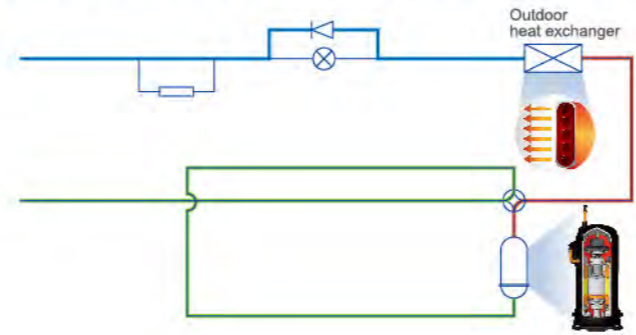

### Inspection Window for Convenient Checking

Inspection window is available for quick checking of system operation status. No need to open panel for checking, which will be more time-saving and easier for maintenance.

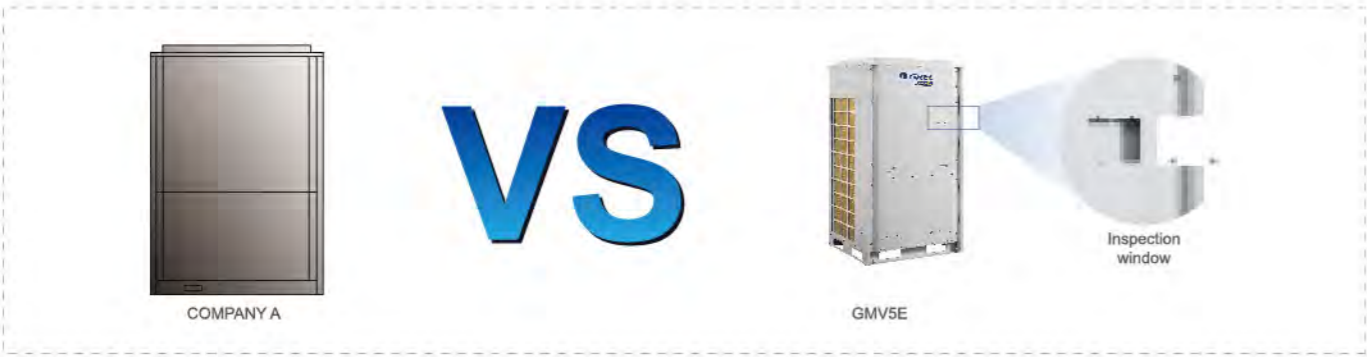

### Flexible Wiring

Common wire can meet the communication demand with no need of specialized communication wire. Common sheath twisted pair cable can be used as there is no polarity requirement.

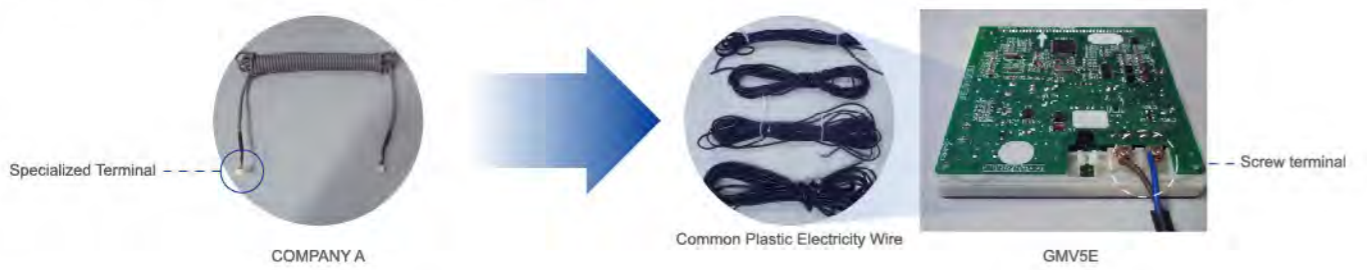

### Auto Addressing of Outdoor and Indoor Unit

CAN network is adopted to achieve auto addressing of outdoor and indoor unit. It can allocate IDU and ODU addresses and detect IDU and ODU quantity, which greatly improves construction efficiency.



## Professional Hotel Functions

Gree GMV5E provides hotels with unique season setting function and key-card control function.

### Season Setting

Cooling or heating mode can be deactivated during a certain season to avoid affecting unit's normal operation due to mode conflict.

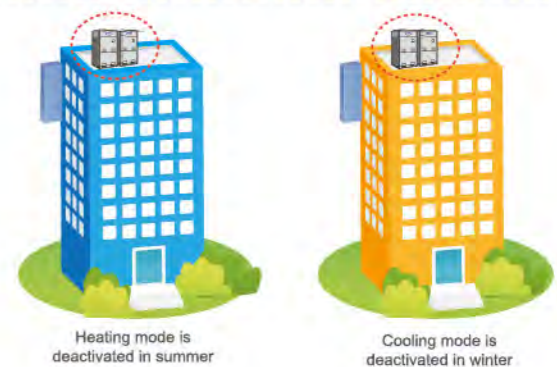

### Key-card Control for Hotel Management

The unit can be turned on or off by inserting or removing the key-card. When the key-card is removed, the system can remember all the setting and stop operation. When the key-card is inserted back, the system will be under standby mode or operate according to the status before removing key-card. It is well suited to hotels, restaurants, etc.





# GMV5 Mini & Slim



## Key Features

### All DC Inverter Technology to Improve Compression Efficiency

All DC inverter compressor and high-performance high pressure chamber are adopted to reduce loss of overheat and improve compression efficiency from direct intake. Compared with low pressure chamber, the compression efficiency is improved. High-efficient permasyn motor is adopted to provide better performance than traditional DC inverter compressor.

### All DC Inverter Compressor

- All DC inverter compressor is used in this system. It can directly intake gas to reduce loss of overheat and improve efficiency.



- High-efficient permasyn motor is adopted to provide better performance than traditional DC inverter compressor.

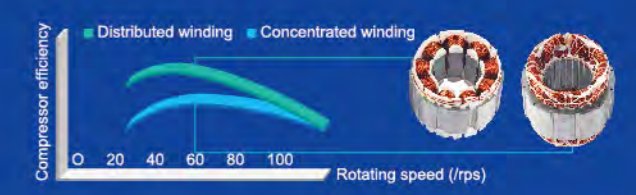

### Technology of Maximum Torque TControl with Minimum Current

It can reduce energy loss caused by device winding so as to realize higher efficiency.

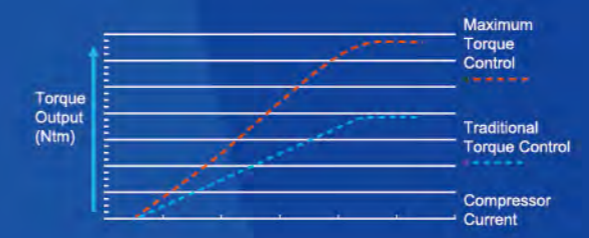

### 180° Sine Wave DC Speed Varying Technology

It can satisfy various places' demands for different temperature and is able to save a great deal of electricity and provide users with utmost comfort at the same time.

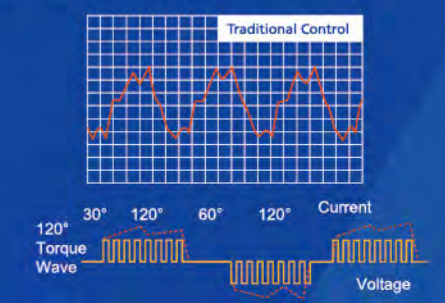

### Low-frequency Torque Control

It can directly control motor torque, through which fan motor can run at a low speed. Users will feel more comfortable while requirements of the system are also met.

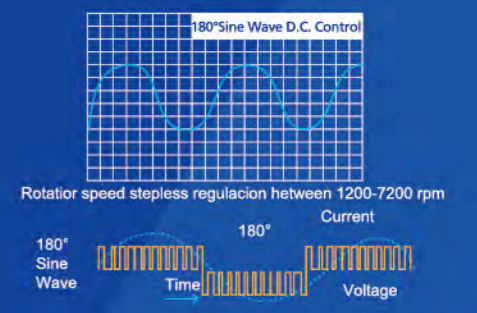

## Sensorless DC Inverter Fan Motor

- Stepless speed regulation ranges from **5Hz** to **44Hz**. Compared with traditional inverter motors, the operation is more energy-saving.

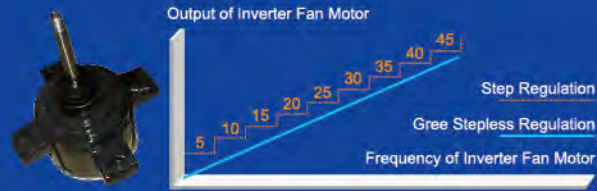

- Sensorless control technology guarantees lower noise, less vibration and steadier operation.

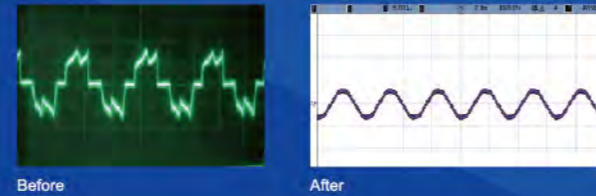

## Sensorless DC Inverter Fan Motor

The indoor unit adopts high-efficiency brushless DC motor. Compared with conventional motor, the efficiency of brushless DC motor is improved by more than **30%**. Meanwhile, the design of evaporation capacity flow is optimized through emulation software of refrigeration system and the heat exchange amount of evaporator is greatly improved.

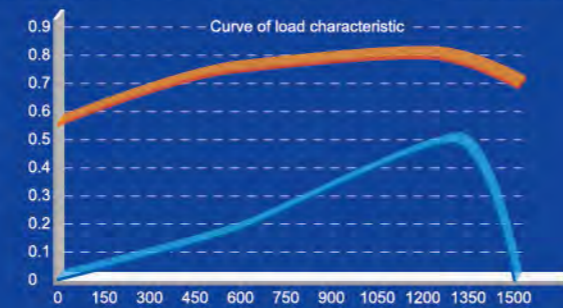

## High-efficiency Digital PFC Control \*

High-efficiency PFC control technology is adopted with efficiency improved by about 1% compared with conventional PFC. For the air conditioner with rated power of 5kW, **50W** of electricity can be saved every hour and **1.2kW** of electricity can be saved every day.

\*This feature is applicable for GMV5 Mini only.

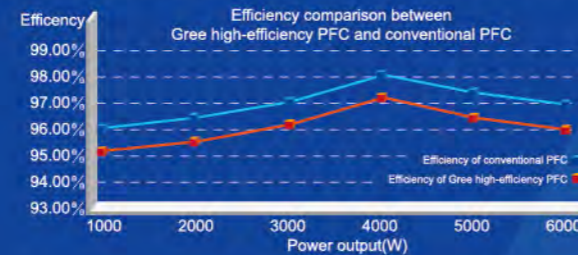

## Wider Operation Condition Range

The unit adopts DC motor with more accurate high pressure control, which effectively solves the high pressure control problem in low ambient temperature cooling. So the operation range in cooling is wider.

Company A	Gree GMV5 Mini	Gree GMV5 Slim
Cooling: 10~48°C Heating: -20~27°C	Cooling: -5~52°C Heating: -20~27°C	Cooling: -5~52°C Heating: -20~27°C

## Comfortable and Quiet Mode

### Low Noise of Outdoor Unit

- The advanced sub-cooling control technology is applied to reduce the liquid flow noise of indoor unit in cooling operation.
- Noise of outdoor unit can be as low as 45dB thanks to noise optimized design of fan system and compressor system, and multiple kinds of quiet modes of outdoor unit.



### Low Noise of Indoor Unit

- The pioneering and patented high-efficiency centrifugal fan blade and low-noise volute are adopted. Meanwhile, the imported silent valve is adopted to reduce noise of entire unit as low as 22db(A).

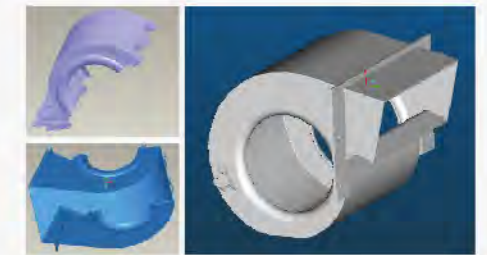

- By adopting the optimal inlet angle of centrifugal fan blade and optimal diameter ratio between internal and external circles of impeller, the air volume is increased and fan noise is decreased greatly.

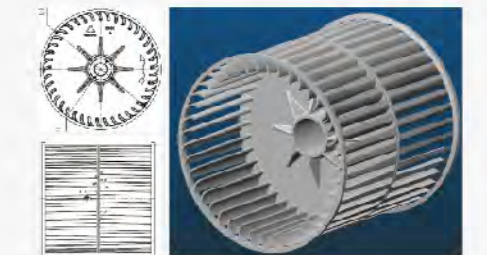

- The advanced supercooling control technology and the oil-return technology under heating mode has efficiently solved the problem of liquid flow noise of indoor unit, which improved the sound quality of indoor unit.

### Intelligent Temperature Control Technology

Intelligent temperature control technology is adopted for super fast cooling or heating, so that indoor temperature will reach set temperature more quickly.



## Comfortable Heating

Advanced intelligent defrosting mode is adopted. Gree advanced intelligent defrosting mode will choose the best defrosting way according to outdoor temperature and operation status to realize intelligent defrosting, effectively improving heating effect and performance. While in traditional defrosting mode, timing defrosting is adopted, which not only affects comfort but also reduces energy efficiency.

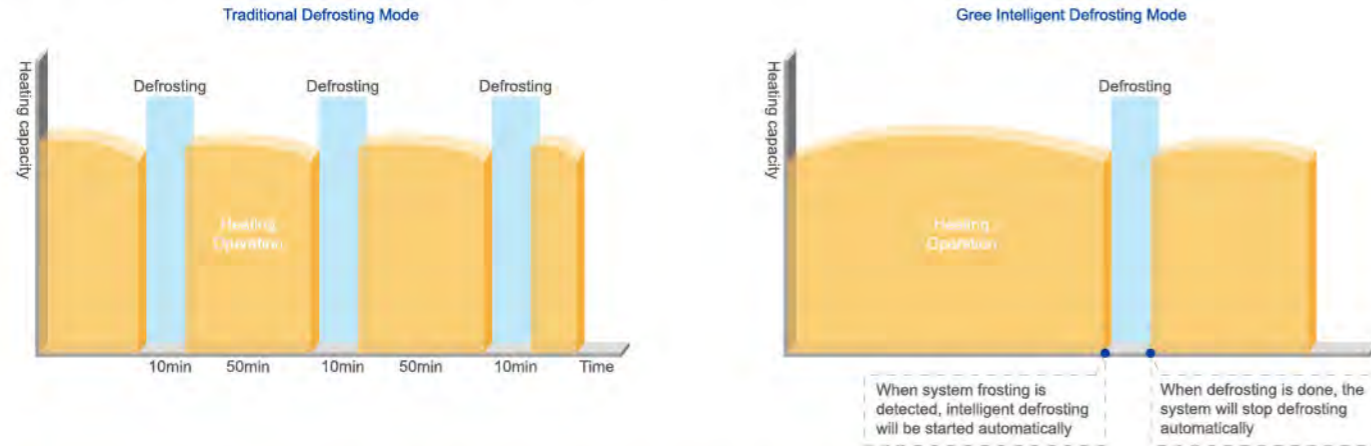

## Non-commutative Oil Return Technology in Heating

The unit can achieve non-commutative oil return in heating when outdoor ambient temperature is within 0~20°C. Thanks to this technology, indoor ambient temperature is more stable and comfort is improved in heating mode.

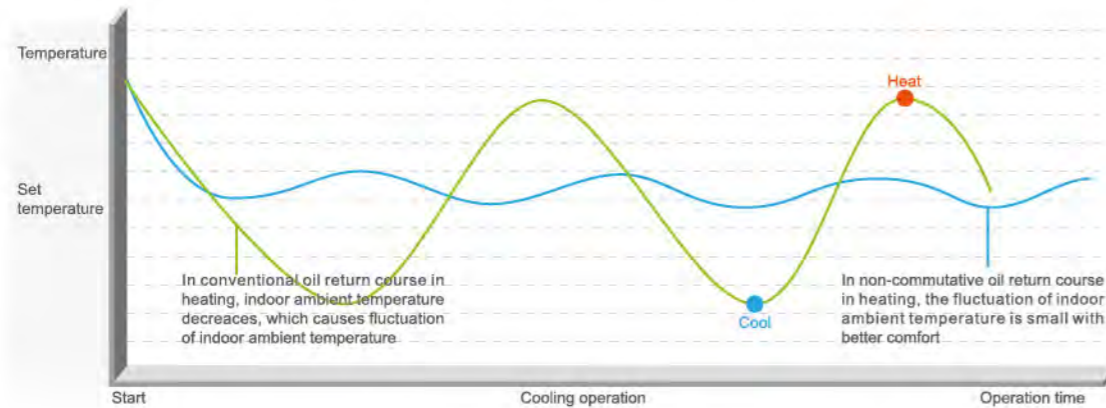

## Reliable Operation

### Compressor Closed-loop Startup Technology with More Reliable Startup

The self-innovative closed-loop startup control technology is adopted. Thanks to this technology, the startup current is small and startup is more reliable.



### High Anti-interference Ability

The latest CAN bus communication technology is adopted, with non-polar communication and high anti-interference ability. Common communication wire can meet the communication demand with no need of specialized shielded wire. The customers can buy the communication wire by themselves, greatly reducing installation difficulties.



### Advanced High-frequency Transformer with More Stable Voltage

- The advanced switching power supply is adopted with lower power consumption and higher power efficiency.
- Wide voltage-regulation range ensures stable voltage output when the voltage of grid fluctuates.
- Compared with conventional transformer, the size of high-frequency transformer is small and the weight is light.

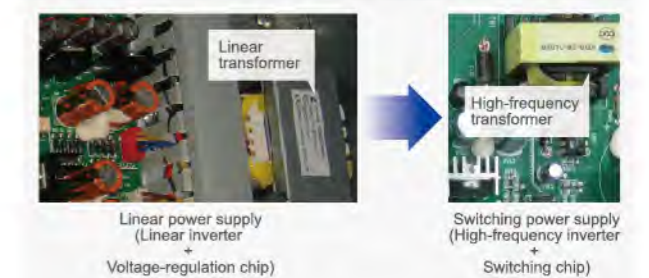

### Refrigerant Cooling Technology\*

- Usually, air-cooled fins are adopted for heat radiation. Due to large size and passive radiation, heat radiating effect is unsatisfactory; with refrigerant cooling technology, heat radiating effect is much better because of compact structure and active radiation. Module temperature is dropped from 80°C to 65°C, which will increase module life and stability.

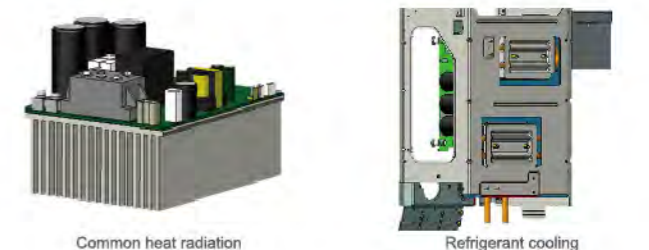

\*: This feature is applicable for GMV5 slim only.

## Easy Installation and Transportation

### Ultra-long Connection Pipe for More Convenient Connection

Under the subcooling control technology gained by adding subcooler, the indoor unit and outdoor unit of GMV5 mini can operate reliably with longer connection pipe.

	Company A	Gree GMV5 Slim	Gree GMV5 Mini
Total piping length	150m	300m	300m
Equivalent piping length	70m	150m	150m

### Top Advanced Light and Compact Size

GMV5 slim adopts small and compact size design. The dimension of the unit is 1430(H)×940(W) ×320(D). Compared with the normal product with the same capacity, size and weight are reduced a lot.

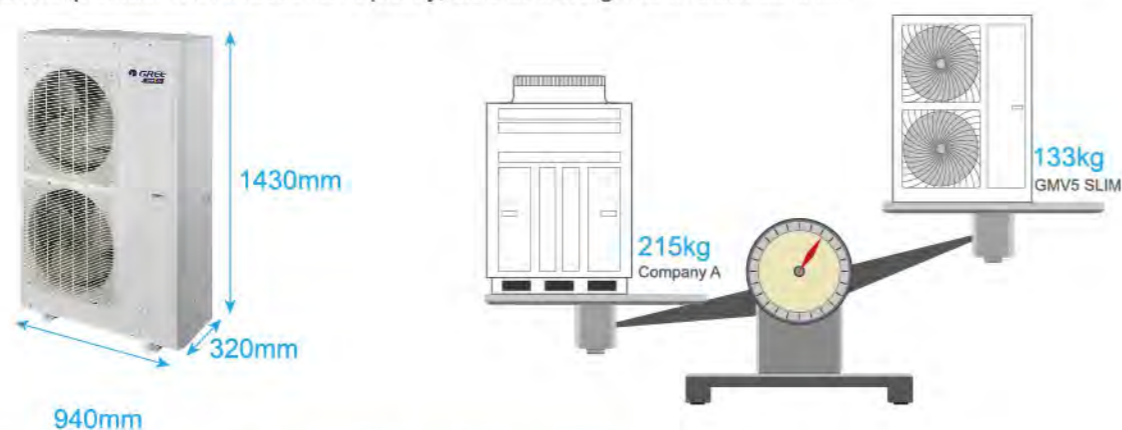

### Easy Installation with Lower Construction Cost

The outdoor unit of GMV5 slim is with small size and light weight. No need fork lifter and crane for movement and installation



### Movement by Stairs and Elevator

The outdoor unit of GMV5 slim is with compact and small size for saving space and easy movement. It can be carried by elevator or stairs.



## GMV5 Mini

### 50Hz&60Hz (220~240V & 208~230V)

Model			GMV-120WL/C-T	GMV-140WL/C-T	GMV-160WL/C-T
Capacity range		HP	4	5	6
Capacity	Cooling	kW	12.1	14	16
	Heating	kW	14	16.5	18
EER		W/W	3.99	3.90	3.37
COP		W/W	4.28	4.18	3.87
Power supply		V/Ph/Hz	220-240/1/50 & 208-230/1/60		
Max. Circuit/Fuse Current		A	32	40	40
Power consumption	Cooling	kW	3.03	3.59	4.75
	Heating	kW	3.27	3.95	4.65
Maximum drive IDU NO.		unit	7	8	9
Refrigerant Charge volume		kg	3.3	3.3	3.3
Sound power level		dB(A)	68	69	69
Connecting pipe	Liquid	mm	9.52	9.52	9.52
	Gas	mm	15.9	15.9	19.1
Dimension(WxDxH)	Outline	mm	900×340×1345	900×340×1345	900×340×1345
	Package	mm	1048×458×1507	1048×458×1507	1048×458×1507
Net weight/Gross weight		kg	112	112	112
Loading quantity	40' GP	set	57	57	57
	40' HQ	set	57	57	57

### 50Hz&60Hz (380~415V)

Model			GMV-120WL/C-X	GMV-140WL/C-X	GMV-160WL/C-X
Capacity range		HP	4	5	6
Capacity	Cooling	kW	12.1	14	16
	Heating	kW	14	16.5	18
EER		W/W	3.99	3.90	3.37
COP		W/W	4.28	4.18	3.87
Power supply		V/Ph/Hz	380-415/3/50&380-415/3/60		
Max. Circuit/Fuse Current		A	16	16	16
Power consumption	Cooling	kW	3.03	3.59	4.75
	Heating	kW	3.27	3.95	4.65
Maximum drive IDU NO.		unit	7	8	9
Refrigerant Charge volume		kg	3.3	3.3	3.3
Sound power level		dB(A)	68	69	69
Connecting pipe	Liquid	mm	9.52	9.52	9.52
	Gas	mm	15.9	15.9	19.1
Dimension (WxDxH)	Outline	mm	900×340×1345	900×340×1345	900×340×1345
	Package	mm	1048×458×1507	1048×458×1507	1048×458×1507
Net weight/Gross weight		kg	122	122	122
Loading quantity	40' GP	set	57	57	57
	40' HQ	set	57	57	57

### GMV5 SLIM 50Hz&60Hz

Model			GMV-224WL/C-X	GMV-280WL/C-X	GMV-335WL/C-X
Capacity range		HP	8	10	12
Capacity	Cooling	kW	22.4	28	33.5
	Heating	kW	24	30	35
EER		W/W	3.66	3.6	3.5
COP		W/W	4.9	4.9	4.9
Power supply		V/Ph/Hz	380-415,3,50/60Hz		
Max. Circuit/Fuse Current		A	17.20	22.4	24.5
Power consumption	Cooling	kW	6.12	7.78	9.57
	Heating	kW	4.9	6.12	7.14
Maximum drive IDU NO.		unit	13	17	20
Refrigerant Charge volume		kg	5.5	7.1	8
Sound power level		dB(A)	74	74	76
Connecting pipe	Liquid	mm	9.52	9.52	12.7
	Gas	mm	19.05	22.2	25.4
Dimension (WxDxH)	Outline	mm	940x320x1430	940x460x1615	940x460x1615
	Package	mm	1038x438x1580	1038x578x1765	1038x578x1765
Net weight/Gross weight		kg	133	166	177
Loading quantity	40' GP	set	56	44	44
	40' HQ	set	56	44	44

Note:  
Gree reserves the right to modify the specifications without prior notice. Please confirm the final specifications with sales representatives.

## Key Features of Indoor Units

### High Static Pressure Duct Type Indoor Unit



- **High static pressure design**

Static pressure can be up to 150Pa, especially suitable for places in need of long distance airflow.

- **Easy maintenance**

The system has maintenance port for easy maintenance.

- **Convenient installation**

You can choose circular air duct or rectangular air duct according to actual needs. Or you can choose different ways of air return.

- **Protection function**

Anti-freezing protection, fan motor overload protection, temperature sensor malfunction protection.

### Low Static Pressure Duct Type Indoor Unit



- **Low static pressure, low noise**

Especially suitable for rooms of compact structure or small installation space. Also, it provides you with a comfortable and quiet living environment.

- **Intelligent drainage device**

Water height difference up to 1.0m, which can effectively drain out condensing water and save space.

Note: Please specify if you need this function.

- **Convenient installation**

Tab type plastic filter, detachable fan motor, independent water pump assembly and electric box assembly, all for convenient maintenance.

- **Protection function**

Water overflow protection, anti-freezing protection, fan motor overload protection, temperature sensor malfunction protection.



## Slim Ducted Type Indoor Unit



- **Highly Efficient & Energy-saving**

High-efficiency DC brushless motor is used. Its efficiency is improved by over 30% compared with common motor. Evaporator flow path adopts simulating optimized design via the refrigeration system simulation software, which has greatly increased the heat exchange capacity of evaporator.

- **Slim & Small**

The unit is only 200mm's thick and 450mm's deep. Suspended ceiling doesn't have to be very high. It is suitable for ordinary rooms.

- **Wiring of Electric Control Box**

Mounting board of electric control box elements are arranged at both sides of the mounting board of fan motor. There is a wire-cross notch on each side so that wiring at both sides of the mounting board of fan motor is convenient and efficient. Strong and weak current are also separated to ensure the effectiveness of weak current signal transmission.

- **Protection Functions**

Anti-freezing protection, fan motor built-in overload protection, temperature sensor error protection

- **Ultra-quiet**

High-efficiency centrifugal fan and ultralow noise volute are developed with ANSYS and Fluent. They have also gained national patents. Meanwhile, inlet mute valve is adopted so that noise of the complete unit is greatly reduced.

- **Fast & Strong**

Intelligent temperature control technology is adopted. Cooling/ Heating function is fast and strong so that room temperature can quickly reach set temperature.

- **Flexible Installation**

Based on the requirements of building and utilization, different ways of air return and different air supply static pressure can be selected.

- **CAN Bus Communication Technology**

System response speed is faster and communication is more reliable. Auto addressing, non-polar communication, free wire matching

- **Convenient Operation & Maintenance**

Electric control box is attached independently so that it can be detached as a whole, which is convenient for maintenance. The installation and maintenance of fan and motor is also convenient.

## 4-way Cassette Indoor Unit

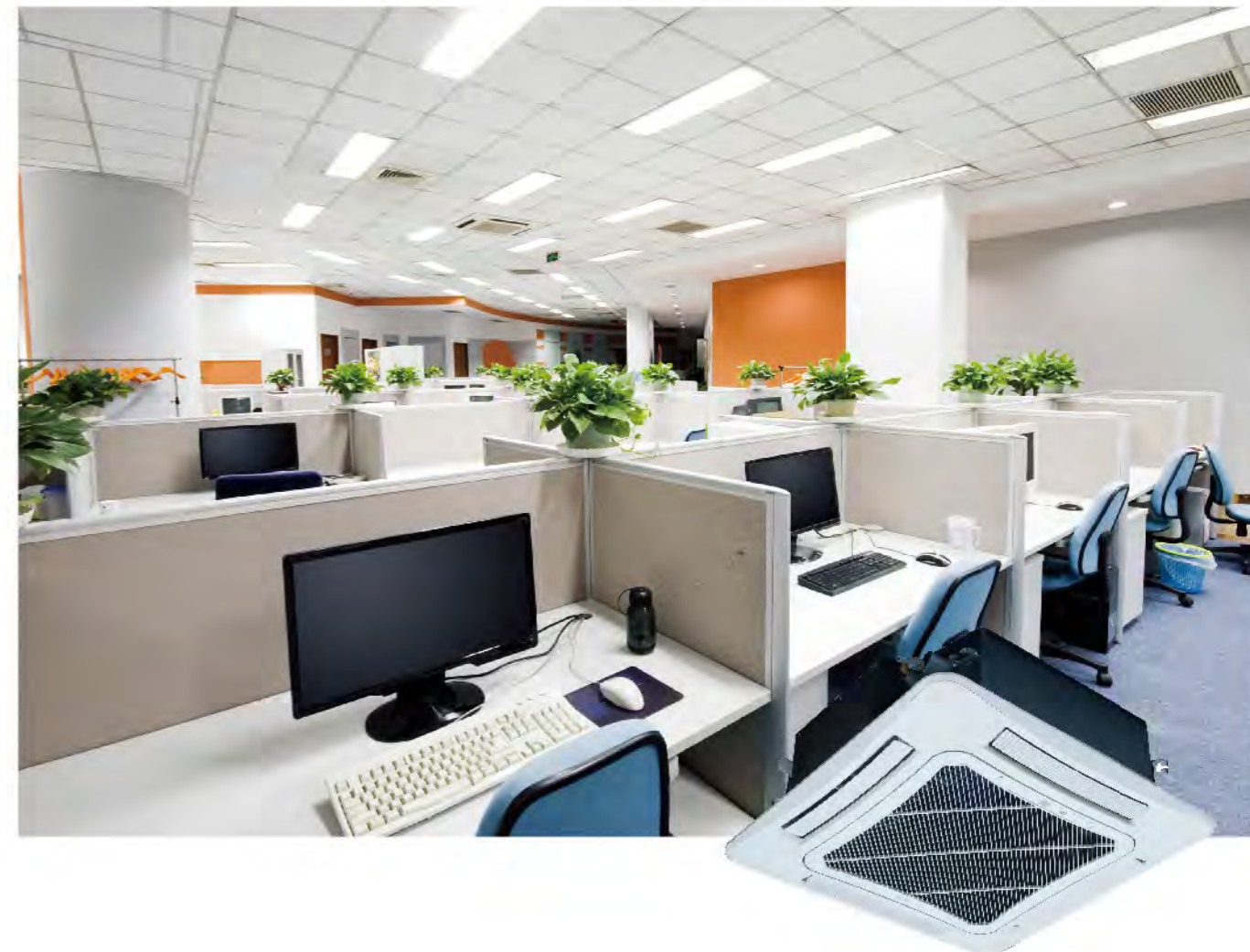

- **Strong and balanced airflow**

Unit features auto operation, 4-way airflow, 7 fan speeds and strong circulating airflow.

- **Ultra-low noise operation**

DC inverter motor can realize stepless speed regulation to lower noise. Indoor unit can be set to work under auto quiet mode via wired controller.

- **Intelligent drainage device**

Water height difference up to 1.0m, which can effectively drain out condensing water and save space.

- **DC inverter motor**

With good speed regulation performance, motor efficiency improved by 30% v.s. normal motor.

- **Protection function**

Water overflow protection, anti-freezing protection, temperature sensor malfunction protection, fan motor overload protection.

## Compact 4-way Cassette Indoor Unit



- Compact Design for Easy Installation**

Units maintain the uniform length and width with consistent ceiling opening and panel dimension, convenient for design and installation;

- Ultra-low noise operation**

DC inverter motor can realize stepless speed regulation to lower noise. Indoor unit can be set to work under auto quiet mode via wired controller.

- Intelligent drainage device**

Water height difference up to 1.0m, which can effectively drain out condensing water and save space.

## 2-way Cassette Indoor Unit



- Beautiful Appearance**

With beautiful and elegant front panel, it is congenial to the indoor surroundings.

- Intelligent drainage device**

Water height difference up to 1.0m, which can effectively drain out condensing water and save space.

- Two-way air flow design**

Two-way air outlet, to stretch air outlet distance and solve air supply problem of elongated room

- Multiple protections**

Anti-freezing protection, temperature malfunction protection, fan motor overload and humidity sensor protection.

## 1-way Cassette Indoor Unit



- Small installation space**  
 With 185mm ultrathin design, unit can be installed in the ceiling of 19cm deep.
- High drain pump lift**  
 Drain pump lift reaches 1.0m, which can effectively drain out water.
- Detachable grille and long life filter**  
 Grille is detachable for easy cleaning. With durable filter, cleaning cycle is 20 times longer.
- Protection function**  
 Water overflow protection, anti-freezing protection, fan motor overload protection, temperature sensor malfunction protection.

## Wall-mounted Indoor Unit



- Comfortable and balanced airflow, up&down air outlet**  
 Up air outlet: In cooling, cool air blows out horizontally and then gradually drops.  
 Down air swing: In heating, warm air blows downward and then gradually climbs up.
- Triple defenders for better purification**  
 Mildew-proof filter, electrostatic fibre and anti-biotic fibre adopted to remove dust, smell, bacteria and mildew.
- Cold air prevention design**  
 During heating in winter, cold air prevention function is enabled so that air won't be blown out until it's warm.
- Multiple protections**  
 Anti-freezing protection, temperature sensor malfunction protection, fan motor overload protection.

## Floor Ceiling Type Indoor Unit



- **Hoisted or seated, flexible installation**

Unit can be hoisted or seated. When seated, suspended ceiling is not needed.

- **Beautiful appearance**

With beautiful and elegant front panel, it is congenial to the indoor surroundings.

- **Protection function**

Anti-freezing protection, temperature sensor malfunction protection, fan motor overload protection.

- **Horizontal and vertical air swing**

Wider air swing range for your comfortable working and living environment.

## Console Indoor Unit



- **Multiple fan speed**

The fan can operate in multiple speed and satisfy different air flow volume requirements.

- **Detachable grille and long life filter**

Grille is detachable for easy cleaning. With long life filter, cleaning cycle is 20 times longer.

- **Protection function**

Anti-freezing protection, fan motor overload protection, temperature sensor malfunction protection.

## Floor Standing Indoor Unit



### Wide Application

It can be widely adopted in hotels, restaurants, office, etc.

### Auto clean to ensure a healthy life

After turning off the unit, the indoor fan will keep running in low speed for a moment to dry the inner components and parts, in order to prevent mildew and keep user healthy.

## Fresh Air Processing Indoor Unit

Airflow volume: 1200~4000m<sup>3</sup>/h  
Applicable range: Residential houses, villas, business buildings, hotels, apartments, etc.



### One system, two functions

- Adopted with DC inverter technology, Fresh Air DC Inverter Multi VRF System features air conditioning function and fresh air function.

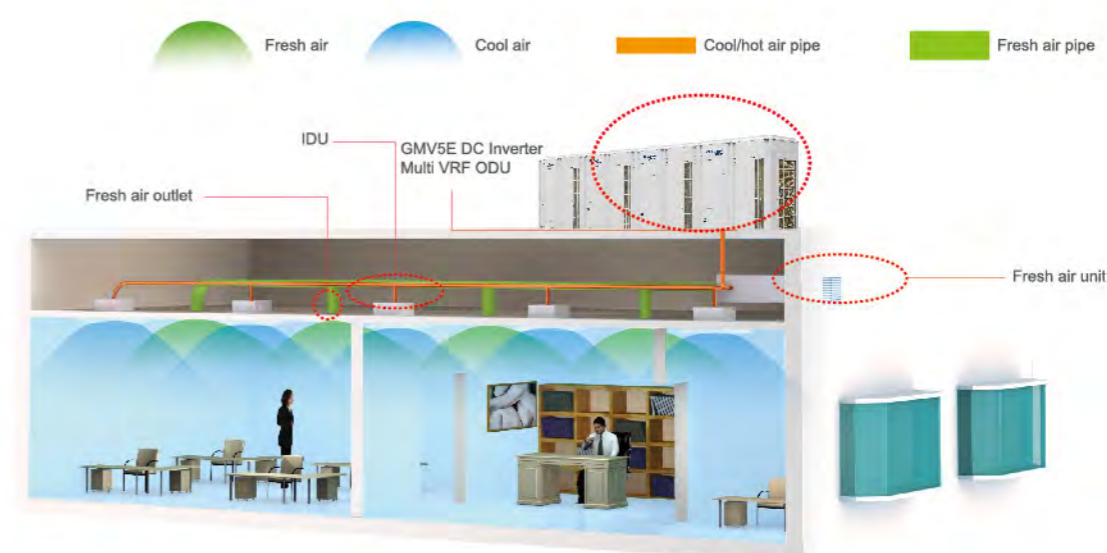

### Enjoy fresh air

- Airflow volume: 1200~4000m<sup>3</sup>/h, cooling capacity: 14-45kW  
Applicable for all kinds of structure.
- Direct evaporative cooling adopted, air conditioning+fresh air can be realized accurately and precisely.
- DC inverter technology adopted, constant humidity is enabled with less power consumption.
- Integrated system control with Gree GMV Multi VRF System.



## Air conditioning and fresh air, two in one

- **Less investment**

Fresh Air DC Inverter Multi VRF System can be combined with Gree GMV5E. For a same room, if the same amount of fresh air is to be taken, then the cost of GMV5E+Fresh air unit is equivalent to the cost of GMV+Air exchange fan.

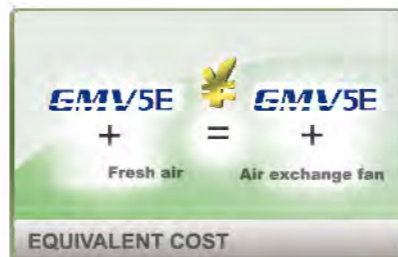

- **Less operation cost**

Unit can control refrigerant output according to actual needs to ensure constant airflow temperature. By adjusting power output, light-load but high power operation can be avoided. Thus, operation cost can be greatly reduced.



- **Less installation space**

Save installation space for outdoor units. Especially suitable for places that have restricted installation space.

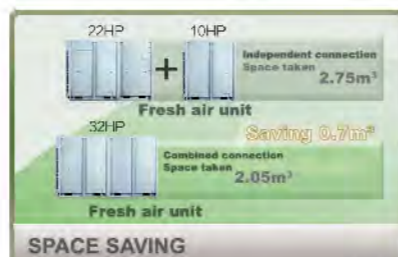

## AHU KIT



- **Maximum capacity**

Capacity of single unit reaches 20HP.

- **Convenient for installation**

EXV is separated from control box, flexible for installation.

- **Adjustable capacity**

Adjust capacity by DIP switch code, flexible and convenient.

## Indoor Units Lineup

### Specifications of Indoor Units

Type of indoor unit	Specification	22	25	28	32	36	40	45	50	56	63	71	72	80	90	100	112	125	140	160	224	280	450	560	
High Static Pressure Duct Type Unit		•	•	•	•	•	•	•	•	•	•	•	•	•	•	•	•	•	•	•	•	•	•	•	•
Low Static Pressure Duct Type Unit		•	•	•	•	•	•	•	•	•	•	•	•	•	•	•	•	•	•	•	•	•	•	•	•
Slim Ducted Type Indoor Unit		•	•	•	•	•	•	•	•	•	•	•	•	•	•	•	•	•	•	•	•	•	•	•	•
4-way Cassette Unit		•	•	•	•	•	•	•	•	•	•	•	•	•	•	•	•	•	•	•	•	•	•	•	•
Compact 4-way Cassette Indoor Unit		•	•	•	•	•	•	•	•	•	•	•	•	•	•	•	•	•	•	•	•	•	•	•	•
2-way Cassette Indoor Unit		•	•	•	•	•	•	•	•	•	•	•	•	•	•	•	•	•	•	•	•	•	•	•	•
1-way Cassette Unit		•	•	•	•	•	•	•	•	•	•	•	•	•	•	•	•	•	•	•	•	•	•	•	•
Wall-mounted Type Unit		•	•	•	•	•	•	•	•	•	•	•	•	•	•	•	•	•	•	•	•	•	•	•	•
Floor Ceiling Type Indoor Unit		•	•	•	•	•	•	•	•	•	•	•	•	•	•	•	•	•	•	•	•	•	•	•	•
Console Indoor Unit		•	•	•	•	•	•	•	•	•	•	•	•	•	•	•	•	•	•	•	•	•	•	•	•
Floor Standing Type Indoor Unit		•	•	•	•	•	•	•	•	•	•	•	•	•	•	•	•	•	•	•	•	•	•	•	•
Fresh Air Processing Indoor Unit		•	•	•	•	•	•	•	•	•	•	•	•	•	•	•	•	•	•	•	•	•	•	•	•
AHU KIT		•	•	•	•	•	•	•	•	•	•	•	•	•	•	•	•	•	•	•	•	•	•	•	•









### Wall-mounted Type Indoor Unit 50 Hz

Model			GMV-N22G/A3A-K*	GMV-N28G/A3A-K*	GMV-N36G/A3A-K*	GMV-N45G/A3A-K*	GMV-N50G/A3A-K*	GMV-N56G/A3A-K*	GMV-N63G/A3A-K*	GMV-N71G/A3A-K*	
Capacity	Cooling	kW	2.2	2.8	3.6	4.5	5.0	5.6	6.3	7.1	
	Heating	kW	2.5	3.2	4.0	5.0	5.8	6.3	7.0	7.5	
Power supply	V/Ph/Hz		220-240/1/50								
Power consumption	W		50	50	60	60	60	70	70	70	
Airflow volume(H/M/L)	m³/h		500/420/350	500/420/350	630/550/480	630/550/480	630/550/480	750/600/500	750/600/500	750/600/500	
	CFM		294/247/206	294/247/206	371/324/282	371/324/282	371/324/282	441/353/294	441/353/294	441/353/294	
Rated Current	Cooling	A	0.2	0.2	0.31	0.31	0.31	0.31	0.31	0.31	
	Heating	A	0.2	0.2	0.31	0.31	0.31	0.31	0.31	0.31	
	Water Heating	A	/	/	/	/	/	/	/	/	
Sound pressure level(H/M/L)	dB(A)		38/34/30	38/34/30	44/41/38	44/41/38	44/41/38	44/41/38	44/41/38	44/41/38	
Connecting pipe diameter	Liquid	mm	Φ6.35	Φ6.35	Φ6.35	Φ6.35	Φ6.35	Φ9.52	Φ9.52	Φ9.52	
	Gas	mm	Φ9.52	Φ9.52	Φ12.7	Φ12.7	Φ12.7	Φ15.9	Φ15.9	Φ15.9	
Drain pipe	External dia.	mm	Φ20	Φ20	Φ20	Φ20	Φ20	Φ30	Φ30	Φ30	
	Thickness	mm	1.5	1.5	1.5	1.5	1.5	1.5	1.5	1.5	
Dimension (WxDxH)	Outline	mm	843x180x275			940x200x298			1008x221x319		
	Package	mm	973x258x370			1068x288x395			1131x398x328		
Net weight/Gross weight	kg		10/12.5	10/12.5	12.5/15.5	12.5/15.5	12.5/15.5	15/18.5	15/18.5	15/18.5	
Loading	40' GP	set	702	702	557	557	557	441	441	441	
	40' HQ	set	819	819	624	624	624	503	503	503	

### 60 Hz

Model			GMV-N22G/A3A-D*	GMV-N28G/A3A-D*	GMV-N36G/A3A-D*	GMV-N45G/A3A-D*	GMV-N50G/A3A-D*	GMV-N56G/A3A-D*	GMV-N63G/A3A-D*	GMV-N71G/A3A-D*	
Capacity	Cooling	kW	2.2	2.8	3.6	4.5	5.0	5.6	6.3	7.1	
	Heating	kW	2.5	3.2	4.0	5.0	5.8	6.3	7.0	7.5	
Power supply	V/Ph/Hz		208-230/1/60								
Power consumption	W		50	50	60	60	60	70	70	70	
Airflow volume(H/M/L)	m³/h		500/420/350	500/420/350	630/550/480	630/550/480	630/550/480	750/600/500	750/600/500	750/600/500	
	CFM		294/247/206	294/247/206	371/324/282	371/324/282	371/324/282	441/353/294	441/353/294	441/353/294	
Rated Current	Cooling	A	0.2	0.2	0.21	0.21	0.21	0.31	0.31	0.31	
	Heating	A	0.2	0.2	0.21	0.21	0.21	0.31	0.31	0.31	
	Water Heating	A	/	/	/	/	/	/	/	/	
Sound pressure level(H/M/L)	dB(A)		38/34/30	38/34/30	44/41/38	44/41/38	44/41/38	44/41/38	44/41/38	44/41/38	
Connecting pipe diameter	Liquid	mm	Φ6.35	Φ6.35	Φ6.35	Φ6.35	Φ6.35	Φ9.52	Φ9.52	Φ9.52	
	Gas	mm	Φ9.52	Φ9.52	Φ12.7	Φ12.7	Φ12.7	Φ15.9	Φ15.9	Φ15.9	
Drain pipe	External dia.	mm	Φ20	Φ20	Φ20	Φ20	Φ20	Φ30	Φ30	Φ30	
	Thickness	mm	1.5	1.5	1.5	1.5	1.5	1.5	1.5	1.5	
Dimension (WxDxH)	Outline	mm	843x180x275			940x200x298			1008x221x319		
	Package	mm	973x285x370			1068x288x395			1131x398x328		
Net weight/Gross weight	kg		10/12.5	10/12.5	12.5/15.5	12.5/15.5	12.5/15.5	15/18.5	15/18.5	15/18.5	
Loading	40' GP	set	702	702	557	557	557	441	441	441	
	40' HQ	set	819	819	624	624	624	503	503	503	

Note:  
\* This series is without water pump.

### Fresh Air Processing Indoor Unit 50/60 Hz

Model			GMV-NX140P/A (X1.2)-K*	GMV-NX450P/A (X4.0)-M*	GMV-NDX224P/A-T*	GMV-NDX280P/A-T*
Capacity	Cooling	kW	14.0	4.5	22.4	28.0
	Heating	kW	10.0	3.2	16.0	20.0
Power supply	V/Ph/Hz		220-240/1/50	380-415/3/50	220-240V/1/50Hz & 208-230/1/60Hz	
Power consumption	W		360	1240	760	860
Airflow volume(H/M/L)	m³/h		1200	4000	2000/2000-3500	2500/2000-3500
	CFM		705	2355	1177/1177-2060	1471/1177-2060
Rated Current	Cooling	A	1.82	2.22	4.3	4.9
	Heating	A	1.82	2.22	4.3	4.9
	Water Heating	A	/	/	/	/
ESP	Pa		150	200	200/50-270	200/50-280
Sound pressure level(H/M/L)	dB(A)		42	58	50	51
Connecting pipe diameter	Liquid	mm	Φ9.52	Φ12.7	Φ9.52	Φ9.52
	Gas	mm	Φ15.9	Φ28.6	Φ19.05	Φ22.2
Drain pipe	External dia.	mm	Φ30	Φ33	Φ30	Φ30
	Thickness	mm	1.5	3.0	1.5	1.5
Dimension (WxDxH)	Outline	mm	1463x756x300	1700x1100x650	1483x791x385	1483x791x385
	Package	mm	1514x785x360	1890x1460x835	1578x883x472	1578x883x472
Net weight/Gross weight	kg		63.5/71	208/266	82/104	82/104
Loading	40' GP	set	84.0	16.0	65	65
	40' HQ	set	98.0	16.0	65	65

Note: \* This series can be matched with GMV5E(Top discharge outdoor unit)only.

### Console Indoor Unit 50/60 Hz

Model			GMV-ND22C/A-T	GMV-ND28C/A-T	GMV-ND36C/A-T	GMV-ND45C/A-T	GMV-ND50C/A-T
Capacity	Cooling	kW	2.2	2.8	3.6	4.5	5.0
	Heating	kW	2.5	3.2	4.0	5.0	5.5
Power supply	V/Ph/Hz		220-240/1/50 & 208-230/1/60				
Power consumption	W		15	15	20	40	40
Airflow volume(H/M/L)	m³/h		400/320/270	400/320/270	480/400/310	680/600/500	680/600/500
	CFM		235/188/159	235/188/159	282/235/182	400/353/294	400/353/294
Rated Current	Cooling	A	0.17	0.17	0.25	0.4	0.4
	Heating	A	0.17	0.17	0.25	0.4	0.4
	Water Heating	A	/	/	/	/	/
ESP	Pa		0	0	0	0	0
Sound pressure level(H/M/L)	dB(A)		38/33/27	38/33/27	40/37/32	46/43/39	46/43/39
Connecting pipe diameter	Liquid	mm	6.35	6.35	6.35	6.35	6.35
	Gas	mm	9.52	9.52	9.52	12.7	12.7
Drain pipe	External dia.	mm	28	28	28	28	28
	Thickness	mm	1	1	1	1	1
Dimension (WxDxH)	Outline	mm	700/215/600	700/215/600	700/215/600	700/215/600	700/215/600
	Package	mm	788x283x777	788x283x777	788x283x777	788x283x777	788x283x777
Net weight/Gross weight	kg		16/19	16/19	16/19	16/19	16/19
Loading	40' GP	set	348	348	348	348	348
	40' HQ	set	348	348	348	348	348

### Floor Ceiling Type Indoor Unit 50/60 Hz

Model			GMV-ND28ZD/A-T	GMV-ND36ZD/A-T	GMV-ND50ZD/A-T	GMV-ND56ZD/A-T	GMV-ND63ZD/A-T	
Capacity	Cooling	kW	2.8	3.6	5.0	5.6	6.3	
	Heating	kW	3.2	4.0	5.6	6.3	7.1	
Power supply	V/Ph/Hz		220-240/1/50 & 208-230/1/60					
Power consumption	W		40	40	50	50	75	
Airflow volume(H/M/L)	m³/h		650/580/500	650/580/500	950/850/700	950/850/700	1400/1150/1000	
	CFM		380/341/294	380/341/294	560/500/410	560/500/410	825/677/590	
Rated Current	Cooling	A	0.2	0.2	0.25	0.4	0.38	
	Heating	A	0.2	0.2	0.25	0.4	0.38	
	Water Heating	A	/	/	/	/	/	
Sound pressure level(H/M/L)	dB(A)		36/34/32	36/34/32	42/38/33	42/38/33	44/42/39	
Connecting pipe diameter	Liquid	mm	Φ6.35	Φ6.35	Φ6.35	Φ9.52	Φ9.52	
	Gas	mm	Φ9.52	Φ12.7	Φ12.7	Φ15.9	Φ15.9	
Drain pipe	External dia.	mm	Φ17	Φ17	Φ17	Φ17	Φ17	
	Thickness	mm	1.75	1.75	1.75	1.75	1.75	
Dimension (WxDxH)	Outline	mm	1220x700x225				1420x700x245	
	Package	mm	1343x823x315				1548x828x345	
Net weight/Gross weight	kg		40/49	40/49	40/49	40/49	50/58	
Loading	40' GP	set	145	145	145	145	90	
	40' HQ	set	158	158	158	158	98	

### Floor Standing Type 50/60 Hz

Model			GMV-ND100L/A-T	GMV-ND140L/A-T
Capacity	Cooling	kW	10	14
	Heating	kW	11	15
Power supply	V/Ph/Hz		220-240/1/50 & 208-230/1/60	
Power consumption	W		185	185
Airflow volume(H/M/L)	m³/h		1850/1600/1400	1850/1600/1400
	CFM		1089/942/824	1089/942/824
Rated Current	Cooling	A	1.5	1.5
	Heating	A	1.5	1.5
	Water Heating	A	/	/
ESP	Pa		0	0
Sound pressure level(H/M/L)	dB(A)		50/48/46	50/48/46
Connecting pipe diameter	Liquid	mm	9	9
	Gas	mm	16	16
Drain pipe	External dia.	mm	31	31
	Thickness	mm	4.5	4.5
Dimension (WxDxH)	Outline	mm	1870x580x400	1870x580x400
	Package	mm	2083/738/545	2083/738/545
Net weight/Gross weight	kg		54/74	57/77
Loading	40' GP	set	67	67
	40' HQ	set	67	67

Model			GMV-ND71ZD/A-T	GMV-ND90ZD/A-T	GMV-ND112ZD/A-T	GMV-ND125ZD/A-T	GMV-ND140ZD/A-T	
Capacity	Cooling	kW	7.1	9.0	11.2	12.5	14.0	
	Heating	kW	8.0	10.0	12.5	14.0	16.0	
Power supply	V/Ph/Hz		220-240/1/50 & 208-230/1/60					
Power consumption	W		75	140	160	160	160	
Airflow volume(H/M/L)	m³/h		1400/1150/1000	1600/1400/1200	2000/1800/1450	2000/1800/1450	2000/1800/1450	
	CFM		825/677/590	940/824/706	1175/1059/853	1175/1059/853	1175/1059/853	
Rated Current	Cooling	A	0.38	0.7	0.95	0.95	0.95	
	Heating	A	0.38	0.7	0.95	0.95	0.95	
	Water Heating	A	/	/	/	/	/	
Sound pressure level(H/M/L)	dB(A)		44/42/39	50/47/43	51/46/42	52/49/45	52/49/45	
Connecting pipe diameter	Liquid	mm	Φ9.52	Φ9.52	Φ9.52	Φ9.52	Φ9.52	
	Gas	mm	Φ15.9	Φ15.9	Φ15.9	Φ15.9	Φ15.9	
Drain pipe	External dia.	mm	Φ17	Φ17	Φ17	Φ17	Φ17	
	Thickness	mm	1.75	1.75	1.75	1.75	1.75	
Dimension (WxDxH)	Outline	mm	1420x700x245				1700x700x245	
	Package	mm	1548x828x345				1828x828x345	
Net weight/Gross weight	kg		50/58	50/58	60/68	60/68	60/68	
Loading	40' GP	set	90	90	84	84	84	
	40' HQ	set	98	98	98	98	98	

### AHU KIT 50/60 Hz

Model			GMV-N38U/A-T	GMV-N71U/A-T	GMV-N140U/A-T	GMV-N280U/A-T	GMV-N580U/A-T
Power			220-240/1/50 & 208-230/1/60				
Defaulted capacity of ex-factory	Cooling	kW	3.6	7.1	14	28	56
	Heating	kW	4	8	16	31.5	62.5
Adjustable capacity	Cooling	kW	2.8/3.6	4.5/5.6/7.1	9/11.2/14	22.4/28	45/50.4/56
	Heating	kW	3.2/4.0	5.0/6.3/8.0	10/12.5/16	25/31.5	50.0/56.5/62.5
Power			5	5	5	5	5
Size of connection pipe	Liquid pipe	mm	Φ6.35/Φ6.35	Φ6.35/Φ9.52/Φ9.52	Φ9.52/Φ9.52/Φ9.52	Φ9.52/Φ9.52	Φ12.7/Φ15.9/Φ15.9
	Gas pipe	mm	Φ9.52/Φ9.52	Φ12.7/Φ15.9/Φ15.9	Φ15.9/Φ15.9/Φ15.9	Φ19.05/Φ22.2	Φ28.6/Φ28.6/Φ28.6
Connection method			Brazing Connection				
Outline dimension (WxDxH)	Electronic expansion valve box	mm	203x326x85	203x326x85	203x326x85	203x326x85	246x500x120
	Control box	mm	334x284x111	334x284x111	334x284x111	334x284x111	334x284x111
Packing size (WxDxH)			mm				
Net weight/gross weight			kg				
Loading	40' GP	set	8.6/11.5	8.6/11.5	8.6/11.5	8.6/11.5	11.8/15.5
	40' HQ	set	981	981	981	981	702
			1090	1090	1090	1090	756

Note:  
Gree reserves the right to modify the specifications without prior notice. Please confirm the final specifications with sales representatives.

# Control System



## Smart Model Selection Software and Debugging Software

### Model Selection Software

Gree multi VRF selection software is a kind of advanced computer program for selecting models automatically in sales and project bidding. It integrates multi VRF selection logic and computer software to provide a user-friendly interactive interface, which is able to automatically recommend suitable models to user according to ambient condition of project and user's demand.

### New Project Setting and Project Design Conditions

After setting up a new model selection project, input the information of project, customer and designer, and select the function type, power supply, design conditions and other information of outdoor unit.

Project Setting

Project Design Conditions

Confirmation

## Model Selection of Indoor Unit and Outdoor Unit

After selecting room type, the software will recommend the suitable indoor unit series automatically. You can also select indoor unit series manually. After inputting the room area or the required air conditioning load, elbows, drop from ODU, etc., the software will recommend the suitable indoor unit model automatically. Select branch and then input its piping length, drop from ODU and other information to connect the branches with indoor unit and outdoor unit. Select the outdoor unit series and the software will recommend the suitable outdoor unit model automatically.

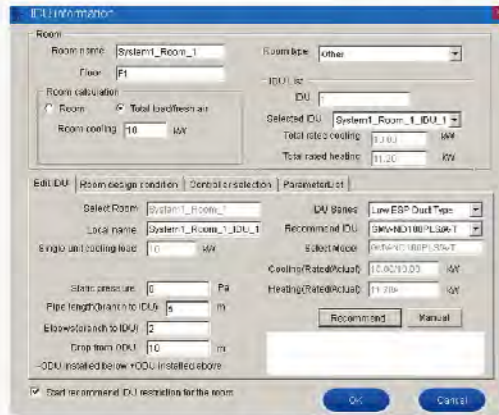

Select IDU

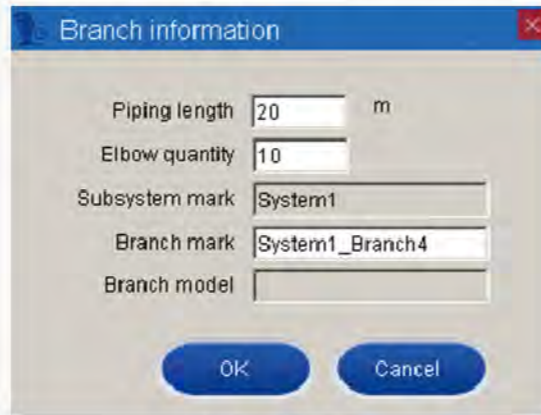

Edit Brand Information

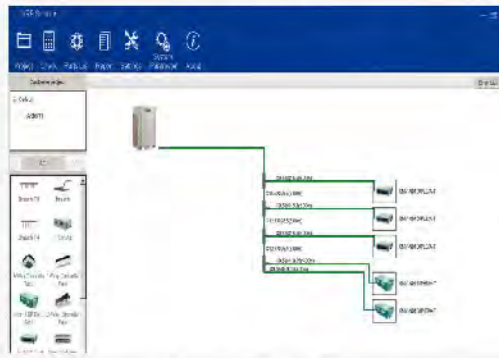

Connection IDU and ODU

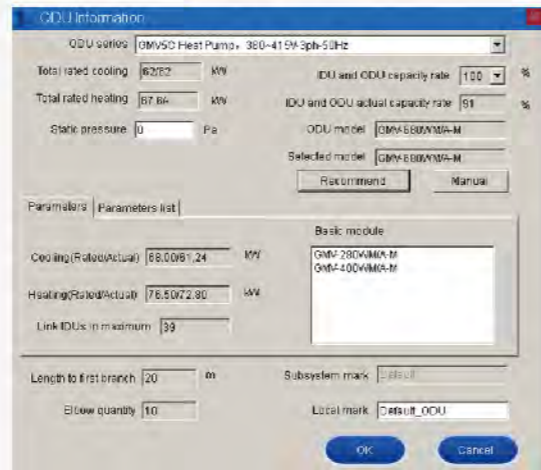

Select ODU

## Check

After finishing the model selection of indoor unit and outdoor, select the check method to check each system in the project and adjust IDU and ODU models.

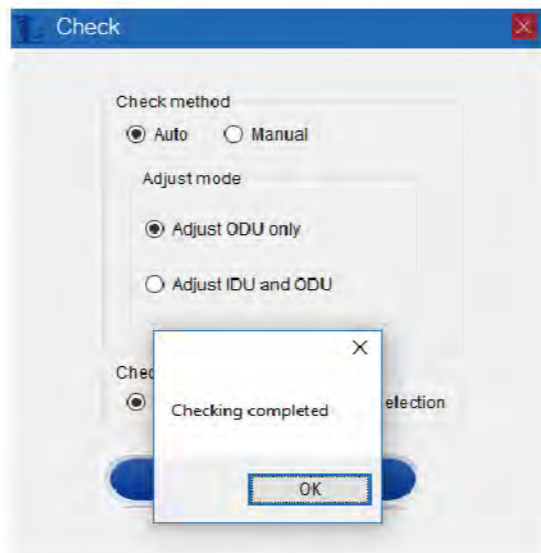

Check

## Electric Configuration and Unit Configuration

After checking, the electric configuration of indoor unit and outdoor unit shall be confirmed. During model selection, metric unit or British unit can be set.

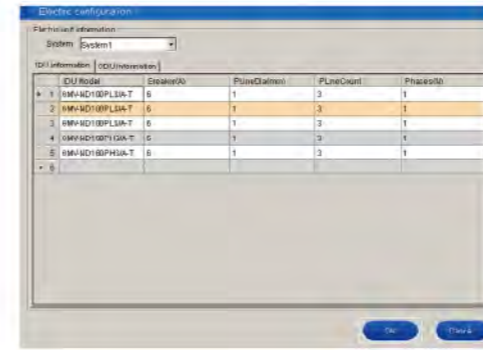

Confirm Electric Configuration



Unit Configuration

## Output Report

After finishing the project settings, the report can be output in excel or CAD format.

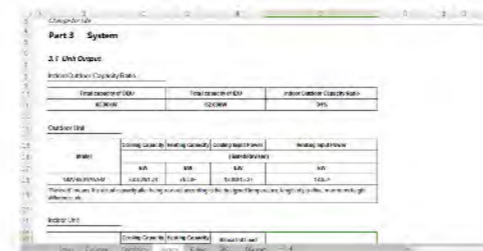

Report in Excel Format

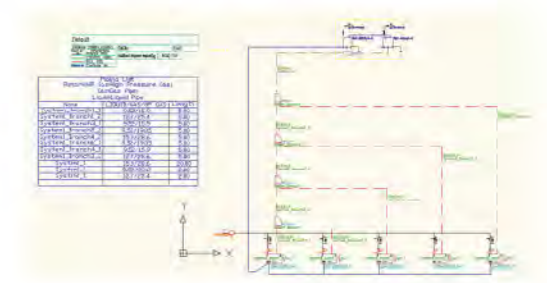

Report in CAD Format

## Intelligent Debugging Software

GMV5E offers an intelligent debugging software to the end-users for faster construction needs.

## Monitoring Functions

- Fully control the operation status of each device of the system;
- Hover the mouse over the parameter to display its remarks.
- The online devices will be displayed in a tree structure;
- Display the information of air conditioner in divided regions;
- Each display region can be moved or concealed;
- Display updated status of units in real time;

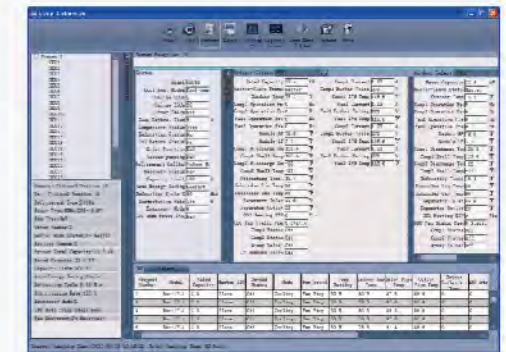

### Control Functions

- Control the operation of unit as you like;
- Comprehensive control of outdoor unit, indoor unit, water tank, hydro box, etc.;
- Real-time display of current status or status after being controlled;
- Both single control and group control are available.

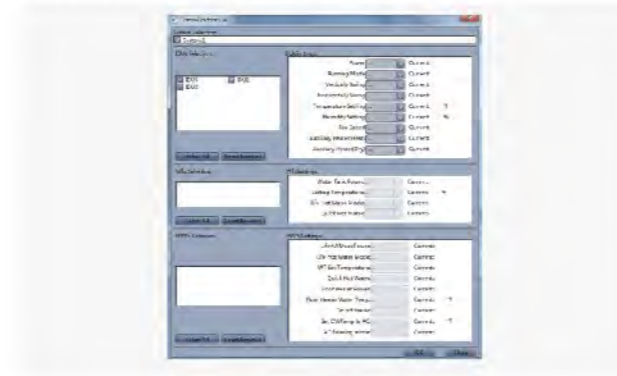

### Project Debugging Functions

- One-click and automatic project debugging;
- Project debugging is arranged step by step from left to right;
- Manual intervention and skipping of some debugging phases are available.
- Green icons will be displayed for the items finishing debugging; red icons will be displayed for the items having debug exception; light yellow icons display debugging information;



### Auto Data-Saving Function

Data will be saved automatically. Database saving path can be changed or data document can be generated repeatedly.

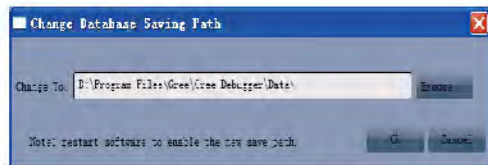

Step 1: Change Database Saving Path

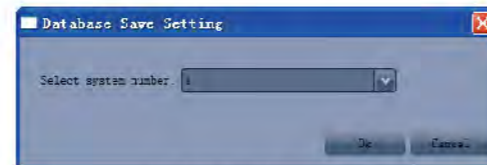

Step 2: Database Save Setting

### USB Data Converter

Users can use USB data converter to freely convert CAN/HBS/RS485 data into USB data, achieving data interchange between computer and air conditioner.

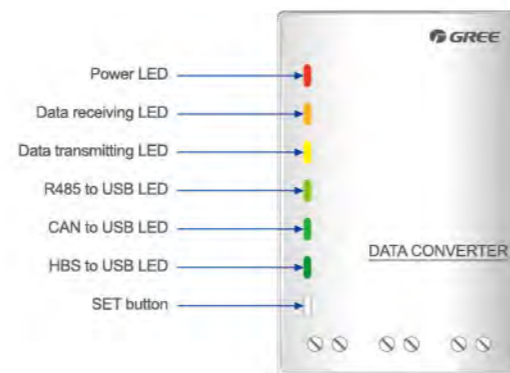

### Auto Direction of Connection Way

The wiring diagram will direct connection way automatically, so that the user can get the connection way quickly.

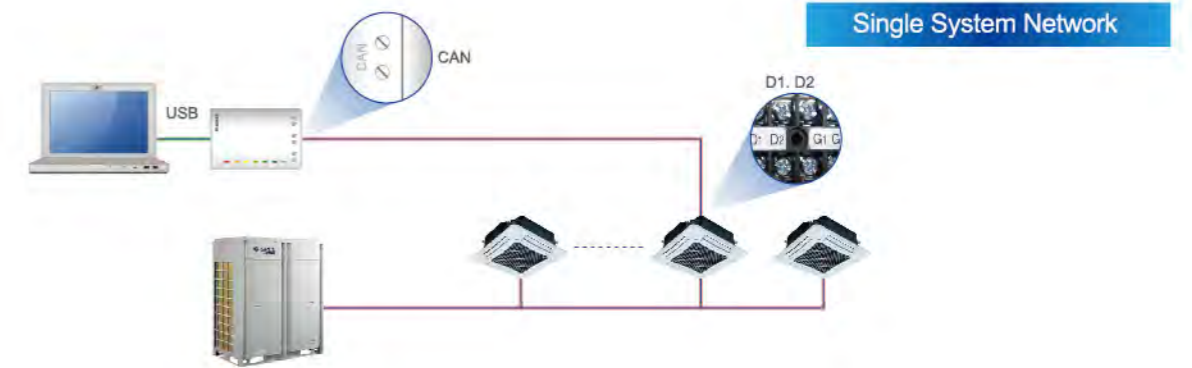

# Multiple Intelligent Remote Control Management

Gree GMV5E provides multiple intelligent controls in order to satisfy all demands. It can control both a room and a building at the same time.

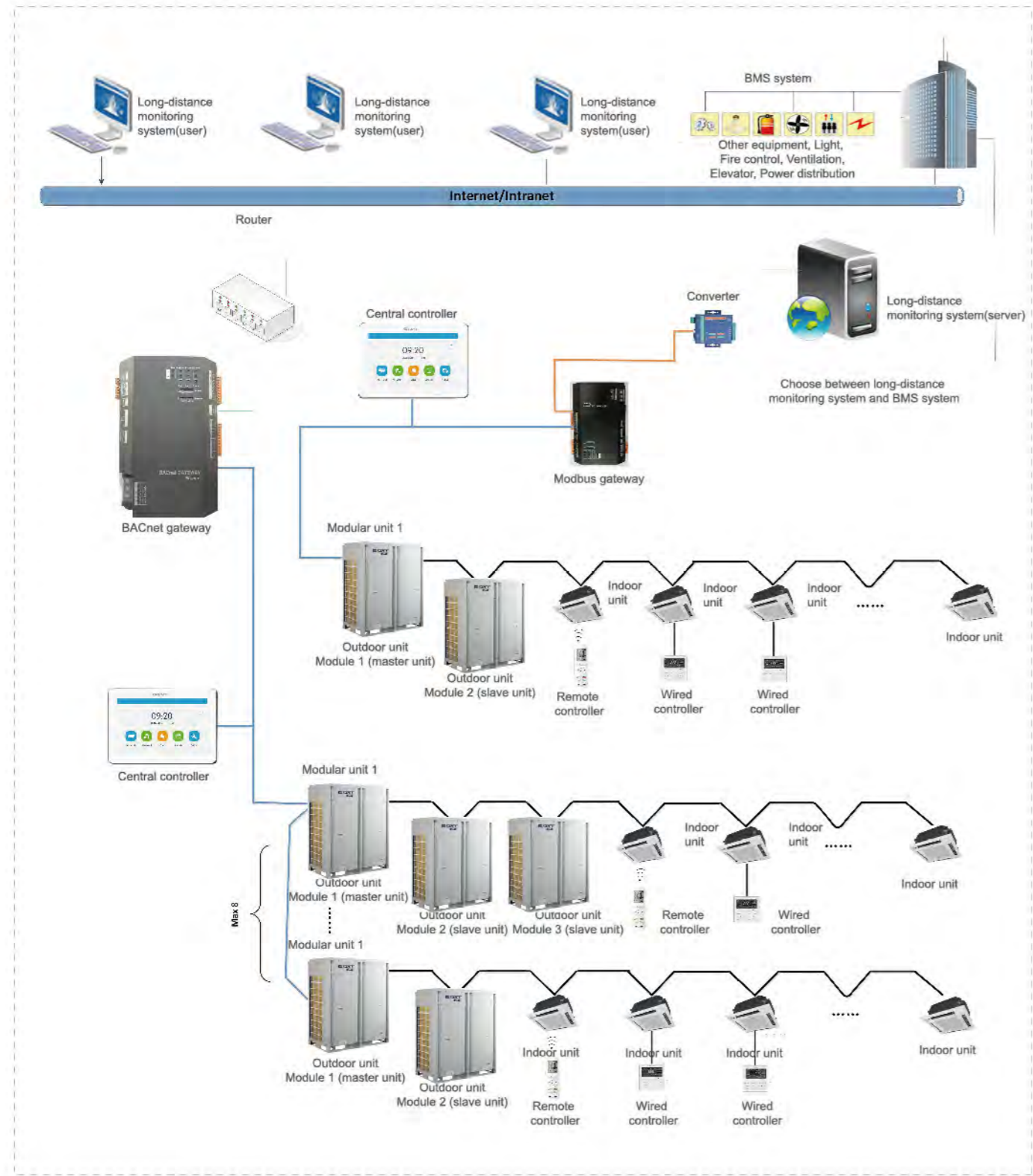

## Visualized Management

- System has a map that can display air conditioners' locations in rooms and buildings.
- System is able to measure the status and number of air conditioners in different levels



## Everyday Management

- **Setting for daily operation**
  - Management in days/weeks/months/years
  - Management in each unit
  - Simple display for management
- **Other functions**
  - Power on/off, modes, humidity, fan speed
  - Waste of energy that may be caused by forgetting to turn off the air conditioner can be avoided
- **Everyday Management at different locations**
  - Management for overtime working
  - Management for meal breaks
  - Management for working time

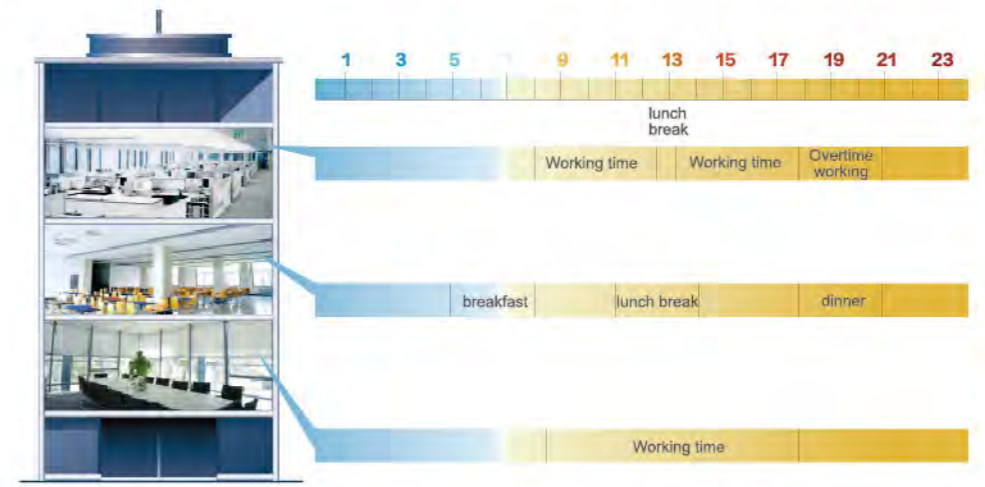

## Group Management

- **Central management in groups**
  - Free choices of dividing groups
  - Central control over power on/off
  - Central control over temperature
  - Central control over modes
  - Central control over user authority



## Authority Management

- Only for indoor units
  - Limited control over power on/off
  - Limited control over temperature
  - Limited control over modes



## VIP Management

System can provide independent and unique service to VIP users.



## BACnet Gateway

Gree BACnet gateway kit ME30-24/D2(B) is intended to realize the data exchange between the air conditioning unit and BAS system, and providing standard BACnet/IP building interface and 10 I/Os (five inputs are DI1, DI2, DI3, DI4, DI5 and five outputs are DO1, DO2, DO3, DO4, DO5). DI1 is the fire alarm interface. The status of other I/Os are mapped to the specific objects of the BACnet/IP bus and are defined by the user.



Applicable Gree air conditioner models for this gateway are GMV5E DC inverter multi VRF unit and GMV5S full-DC inverter multi VRF unit.

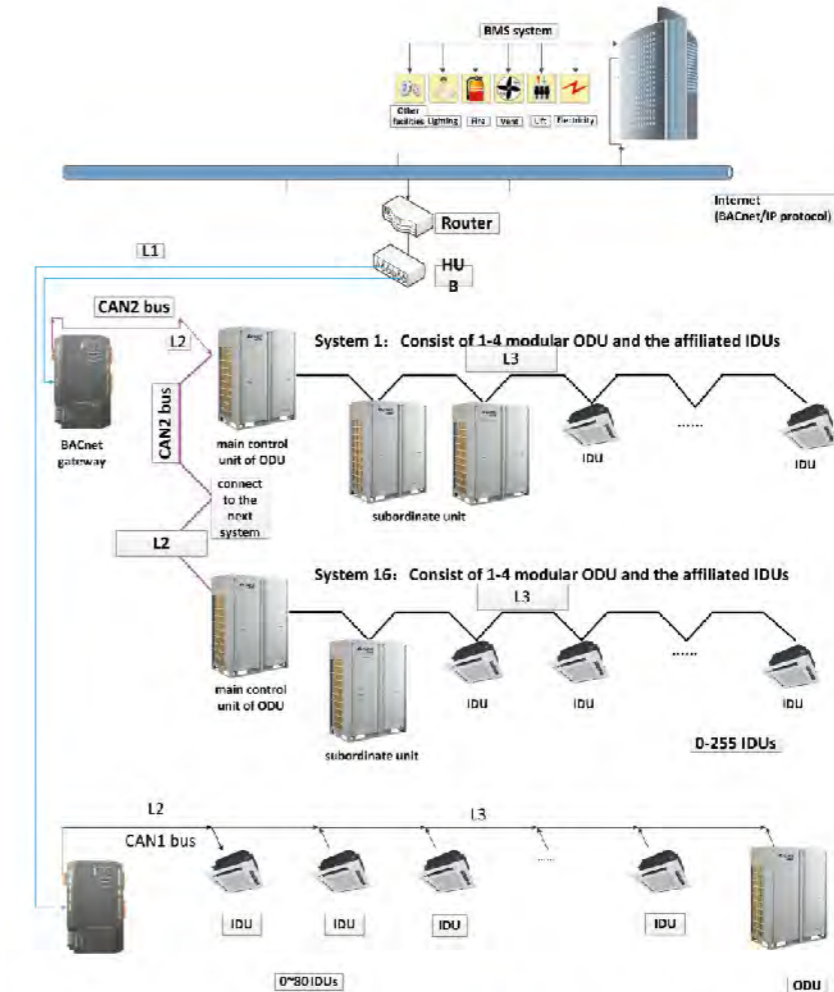

- International standard BACnet/IP interface;
- Real-time monitoring of unit operation status, e.g. on/off, mode, temperature;
- Real-time response to the control of unit (on/off, mode setting and speed setting, etc.) by monitoring software;
- Monitor unit errors;
- Lock unit operation statuses, directing at all control functions of unit itself or a certain setting function;
- Achieve cooling and heating temperature limitation functions;
- 5DI & 5DO interfaces for receiving fire alarm signal and user's definition logic;
- Up to 255 IDU units can be centrally controlled.



## Wired Controller and Remote Controller

There are two kinds of controllers: wired controller and remote controller. The system provides various controls for users, such as cooling, heating, dehumidifying and fan etc., users can select it flexibly according to their own using methods.

### Wired controller XK46



- LCD with black background and white words; touch buttons;
- Clock can be displayed and set; 24 hours timer setting for on/off;
- 7 levels of fan speed, up & down swing and left&right swing;
- Can be switched in auto, cooling, dehumidifying, fan, heating, floor heating, 3D heating and space heating operation modes;
- Master and slave wired controllers can be set; simultaneous control over several IDUs is available;
- Available functions: sleep, ventilation, quiet/auto quiet, light, energy saving, auxiliary heating, drying, memory, low-temperature dehumidifying, absence in heating, controllable auxiliary heating in dehumidifying, filter cleaning reminder, etc.;
- Detect ambient temperature; receive infrared remote controller signal;
- With project parameters viewing and setting functions.

### Wired Controller XK79 (For hotel)



- Small and fashionable appearance with thickness only of 12mm and back lighting LCD with black background and white words;
- Eight touch buttons;
- Clock can be displayed and set in countdown and clock timer;
- Besides normal functions, other functions such as low-temperature dehumidifying, absence in heating, controllable auxiliary heating in dehumidifying and filter cleaning reminder can also be set;
- Door control system can be connected.

### Wired Controller XK55



- Elegant appearance;
- High-resolution color LCD;
- Capacitive touch control; receive infrared remote controller signal;
- Various timing functions: three weekly timers and one countdown timer can be set simultaneously; mode, temperature and fan speed can be preset in weekly timer;
- Complete system functions; each function will be implemented in an individual page with interactive and humanized interface;
- Various personalized functions, e.g. setting brightness and backlight time;
- Sufficient viewing functions, e.g. viewing on/off status and after-sales service hot line.

### Wired Controller XK86



- Elegant and concise appearance;
- Touch buttons with back lighting LCD;
- Chinese and English display can be switched;
- With weekly timer function;
- Complete system functions with each function implemented in an individual page;
- Refreshing, auto dehumidifying, absence and other modes can be set;
- Detect ambient temperature precisely;
- With electricity consumption inquiry function (Unit with electricity measurement function shall be connected);
- With service hotline inquiry and after-sales phone number record functions;

## Remote Controller YAP1F



- Can be switched in auto, cooling, dehumidifying, fan and heating operation modes;
- Besides turbo, 6 levels of fan speed can be set;
- Available functions: child lock, drying, health, ventilation, turbo, sleep, light, absence, I-feel and timer;
- Clock display and indoor/outdoor ambient temperature viewing functions;
- Up & down swing and left & right swing.

## Remote Controller YV1L1



- Back lighting LCD;
- Can be switched in auto, cooling, dehumidifying, fan, heating, floor heating, 3D heating and space heating operation modes;
- 7 levels of fan speed, up&down swing and left&right swing;
- Available functions: child lock, energy saving, drying, health, ventilation, quiet/auto quiet, sleep, light, absence, low-temperature dehumidifying, I-feel and timer;
- With clock display, system parameters viewing and setting functions.

### • Single control of one unit

Each indoor unit has an independent controller.

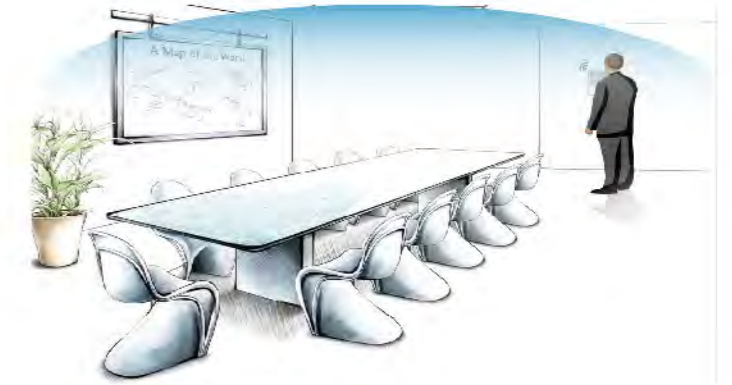

### • Multiple control of one unit

One indoor unit can be controlled by several wired controllers at different places.

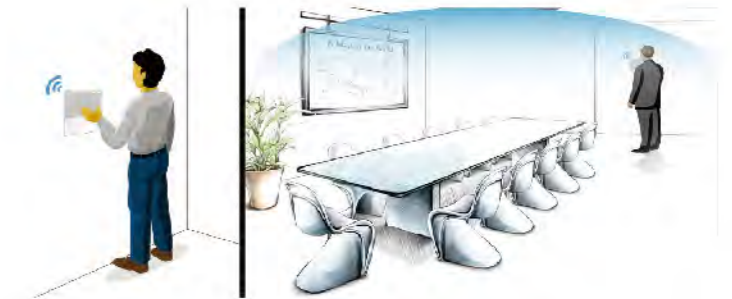

### • Central control of several indoor units

One wired controller can control as many as 16 indoor units.

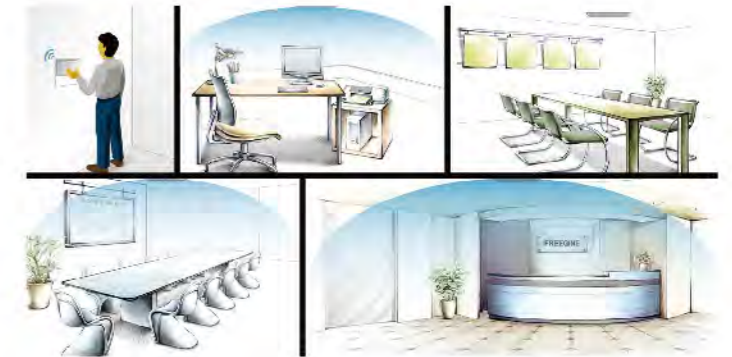

### • Joint control of remote controller and wired controller

Users can control one unit with two types of controllers: a remote controller which is convenient and flexible; or a wired controller which includes every function of an air conditioner.



# Smart Zone Controller and Central Controller

## Smart zone controller CE53-24/F(C)

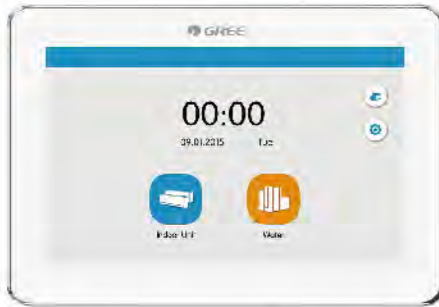

- High-resolution color LCD;
- 7" capacitive touch screen for easy operation;
- Shielding function of single unit, group and all IDUs (shielding on/off, mode, temp setting, etc.);

- With various functions: centralized control(control all indoor units), group management(support DIY grouping), schedule management(setting of several schedules) and single unit control(on/off, mode, temp setting, fan speed, quiet, swing control, etc.);
- Provide naming of indoor units, selection of icons and personalized settings(setting background, backlight, etc);
- Up to 32 units can be centrally controlled;
- Elegant and fashionable appearance;
- Embedded installation in wall with projecting thickness only of 11mm;
- Connectable with network of indoor units or outdoor units;
- Independent power supply in 110~240V wide voltage range;
- With project setting, parameter viewing, malfunction record and access management functions.

## Central controller CE52-24/F(C)



- High-resolution color LCD;
- 7" capacitive touch screen for easy operation;
- With project setting, parameter viewing, malfunction record and access management functions.

- With various functions: centralized control(control all indoor units), group management(support DIY grouping), schedule management(setting of several schedules) and single unit control(on/off, mode, temp setting, fan speed, quiet, swing control, etc.);
- Shielding function of single unit, group and all IDUs (shielding on/off, mode, temp setting, etc.);
- Provide naming of indoor units, selection of icons and personalized settings(setting background, backlight, etc);
- Up to 255 units can be centrally controlled;
- Elegant and fashionable appearance;
- Embedded installation in wall with projecting thickness only of 11mm;
- Connectable with network of indoor units or outdoor units;
- Independent power supply in 110~240V wide voltage range;

## E-smart Zone Controller CE54-24/F(C)



- Adopt built-in type installation; the exposed part is only 11mm;
- High resolution colorful LCD;
- 4.3 inch capacitive touch screen for easy operation;
- With single indoor unit control(including general functions and advanced functions), group indoor units control(including general functions and advanced functions), group management(supporting DIY group), single indoor unit and group indoor units timer functions;(general function: ON/OFF, Mode, Set, Fan, Swing, etc; advance functions: Save, Sleep, E-heater, Absence, Quiet, Turbo, etc)
- With long-distance shield function (shield switch, mode, set, etc) for single unit, group and all indoor units;
- Support denomination for indoor units, and icon selection, realizing individuation management;
- Support maximum 32 indoor units, with powerful function;
- Indoor or outdoor unit network can be connected, simple and flexible;
- 110~240V super wide voltage for independent power supply, stable and reliable;
- With functions of engineering setting, parameters view, malfunction view and authority management, easy for debugging and maintenance.

## Modbus Gateway

Modbus Gateway provides GMV5E system with the Modbus protocol interface when connecting to the Building Management System(BMS) in order to achieve central control and remote control over GMV5E system by BMS.

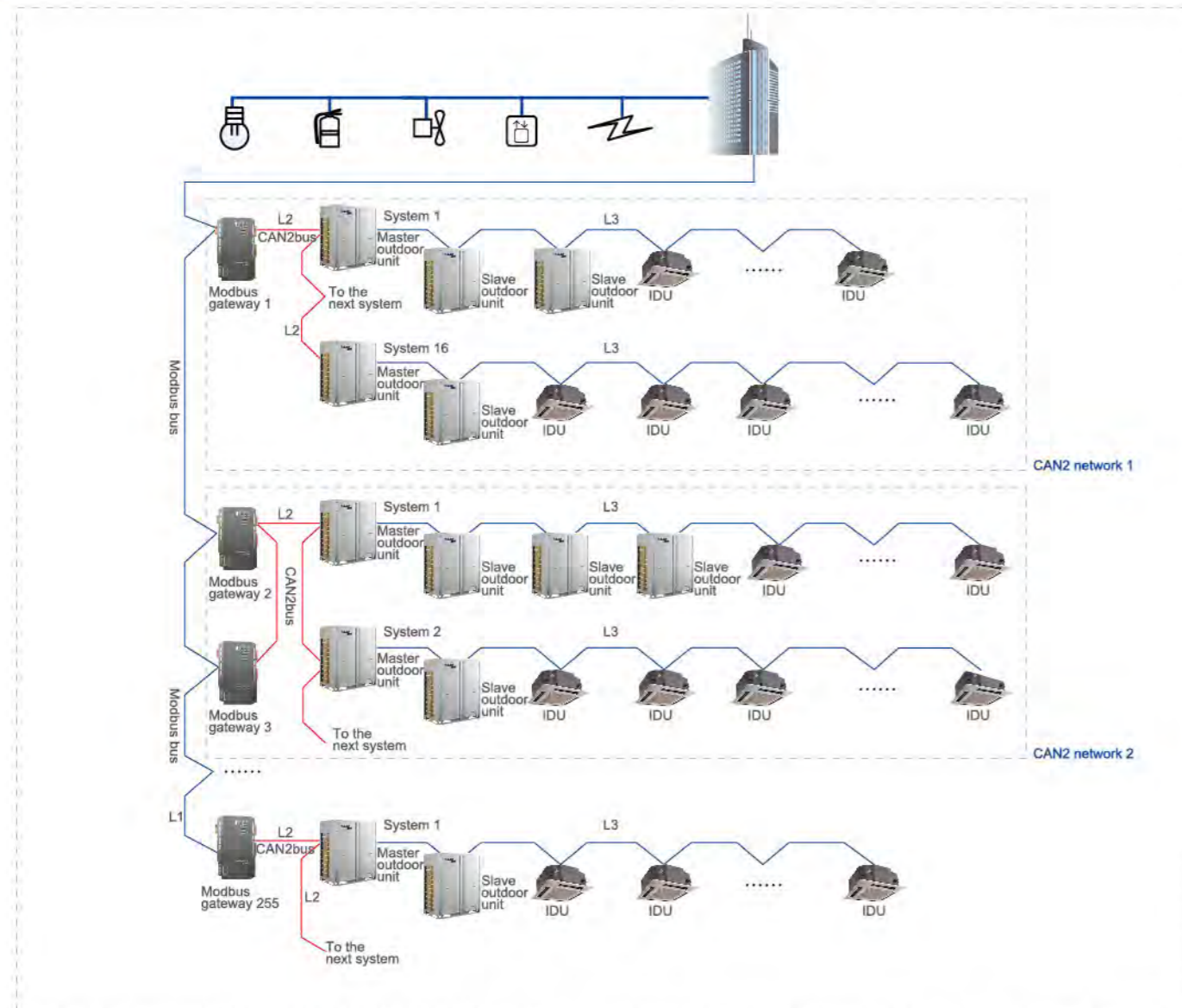

Applicable models: GMV5E All DC Inverter Multi VRF System, GMV5 DC Inverter Multi VRF System, GMV DC Inverter Water Cooled Heat Pump Multi VRF System.

- Real-time monitoring of unit operation status, e.g. on/off, mode, temperature;
- Real-time response to the control of unit (on/off, mode setting and speed setting, etc.) by monitoring software;
- Control all the units switches of on and off.
- Monitor unit errors;
- One Modbus bus can support up to 255 gateways. One Modbus gateway can support at most 16 outdoor units(up to 64 modular outdoor units) and 128 indoor units;
- Lock unit operation statuses, directing at all control functions of unit itself or a certain setting function;
- Linkage control, supporting 5 DI and 5 DO for receiving fire alarm signal and user's definition logic;
- CAN, RS485 communication ports are non-polar, convenient for construction wiring;
- Achieve cooling and heating temperature limitation functions;
- 100-240 VAC,50/60Hz wide voltage range, adapted to the power supply of each country and region.





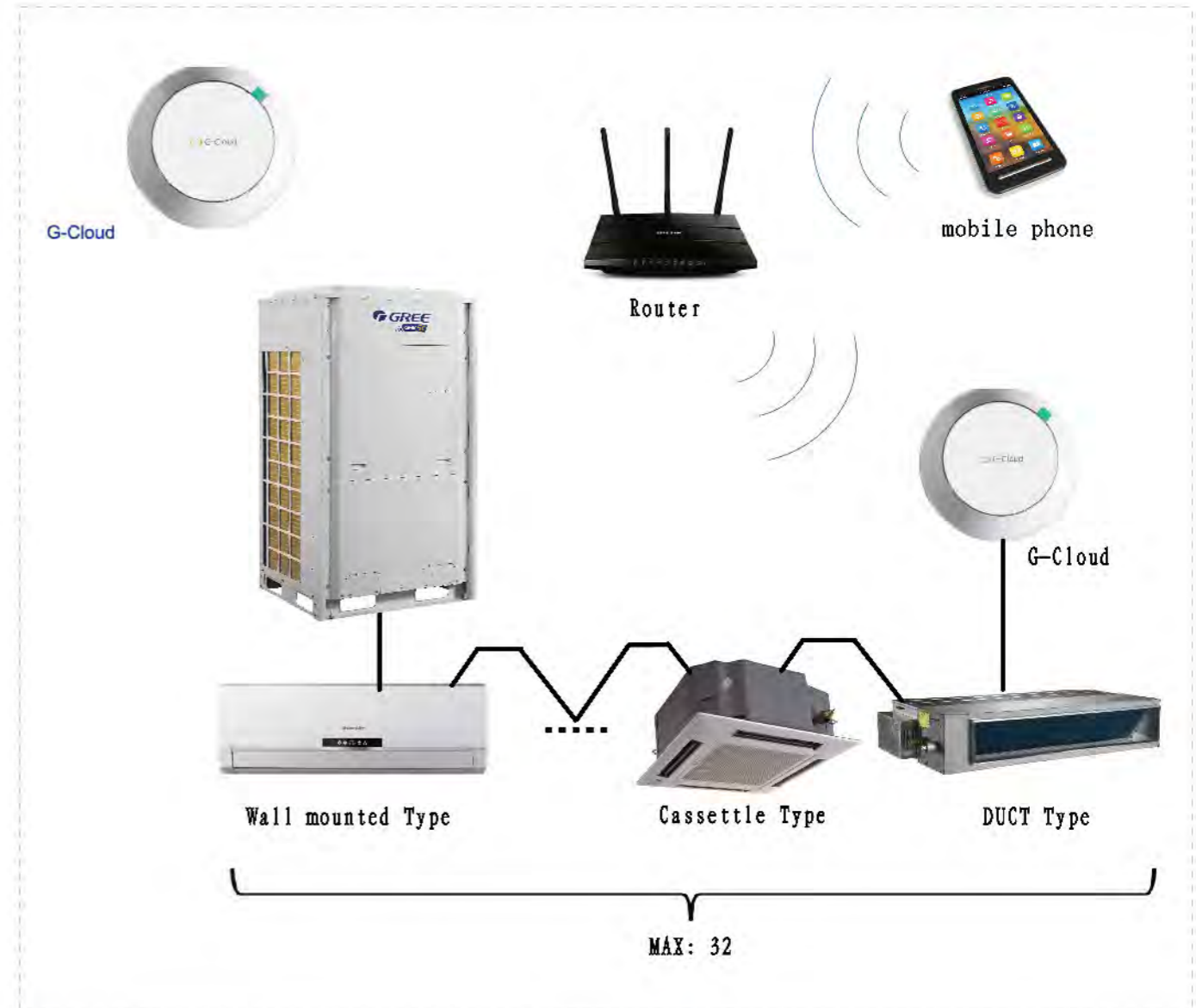











## G-Cloud

G-Cloud shall be operated with smart phone, Gree Smart and wireless router. Configure the smart phone and G-Cloud in the same router to achieve smart control, preset management, scene management, device linkage and other functions.



- Quick configuration: Connection between smart phone and G-Cloud can be achieved through pressing one button, so the configuration is quite simplified;
- Device control: User can set temperature, unit on/off and operation mode through the smart phone and view operation parameters in real time;
- Long-distance control: User can control the device from long distance through the Internet after login (G-Cloud shall be linked to the Internet);
- Scene setting: A series of commands can be set to form a scene and then you can activate the scene just by pressing one button.
- Device linkage: According to the trigger conditions set by the user, linkage in devices can be achieved;
- Preset function: User can set preset function according to his own requirement, so the device will operate automatically according to the setting.

## Control System Lineup

Controlling system		Product series	Cassette Type	(High ESP, Low ESP, Slim Ducted) Duct Type	Fresh Air Processing	Wall mounted Type	Floor Ceiling Type	Console Type	Floor Standing Type	Air Handler
Wireless Controller		YAP1F 	●	○	○	●	●	●	●	○
		YV1L1 	○	○	○	○	○	○	○	○
Wired controller		XK46 	○	●	●	○	○	○	○	●
		XK79 	○	○	○	○	○	○	○	○
		XK55 	○	○	○	○	○	○	○	○
		XK86 	○	○	○	○	○	○	○	○
		JS05(receiver) 		○	○					
Centralized Controller		CE52-24/F(C) 	○	○	○	○	○	○	○	○
Smart Zone Controller		CE53-24/F(C) 	○	○	○	○	○	○	○	○
E-Smart Zone Controller		CE54-24/F(C) 	○	○	○	○	○	○	○	○
Long-distance monitoring software		FE31-00/AD(BM) 	○	○	○	○	○	○	○	○
BMS Accessories	Communication module(modbus)	ME30-24/E4(M) 	○	○	○	○	○	○	○	○
	GMV BACnet gateway (BACnet)	ME30-24/D4(B) 	○	○	○	○	○	○	○	○
Other modules	Optoelectronic isolated converter	GD02 	○	○	○	○	○	○	○	○
	Optoelectronic isolated signal multiplier	RS485-W 	○	○	○	○	○	○	○	○
G-Cloud		ME31-00/C2 	○	○	○	○	○	○	○	○

Note: ● means standard, ○ means optional.

## Note

---

---

---

---

---

---

---

---

---

---

---

---

---

---

---

---

---

---

---

---

---

---

---

---

---

# Note

# Award and Certification

