

# FREE MATCH III Multi VRF

(GC201305-I)

GREE MAKING BETTER AIR CONDITIONERS GREE MAKING BETTER AIR CONDITIONERS GREE MAKING BETTER AIR CONDITIONERS

TECHNICAL SALES GUIDE-50Hz  
CAPACITY RANGE:18~42kBtu/h  
SUPER HIGH AMBIENT OPERATION TO 52 °C

GREE MAKING BETTER AIR CONDITIONERS GREE MAKING BETTER AIR CONDITIONERS GREE MAKING BETTER AIR CONDITIONERS

R410A



GREE ELECTRIC APPLIANCES INC.OF ZHUHAI

# CONTENTS

- 1. OUTLINE OF MULTI VRF ..... 1
- 2. SUMMARY OF SYSTEM EQUIPMENTS ..... 4
- 3. BASIC SYSTEM CONFIGURATION..... 9
- 4. EQUIPMENT SELECTION PROCEDURE ..... 10
- 5. REFRIGERANT PIPING DESIGN ..... 14
- 6. WIRING DESIGN ..... 21
- 7. ACCESSORIES ..... 24
- 8. TECHNICAL SPECIFICATIONS..... 25
- 9. FAN CHARACTERISTICS..... 62
- 10. DIMENSIONAL DRAWINGS ..... 64

## 1 OUTLINE OF MULTI VRF

### ➔ No sweating

No sweating is needed for the pipe connection between the indoor and outdoor units, simplifying and easing largely the pipe installation.

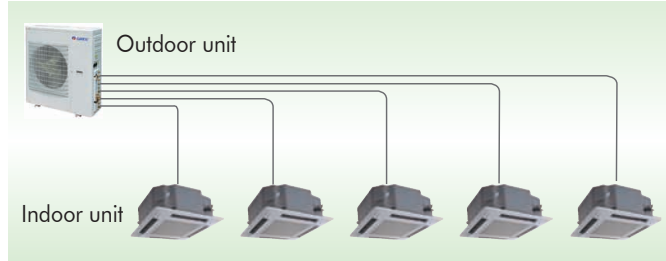

### ➔ Simple Wiring

No dedicated communication line is needed between the indoor and outdoor unit, since the communication is available through the heavy-current carrier signals as soon as the electric wiring between the indoor and outdoor units gets ready.

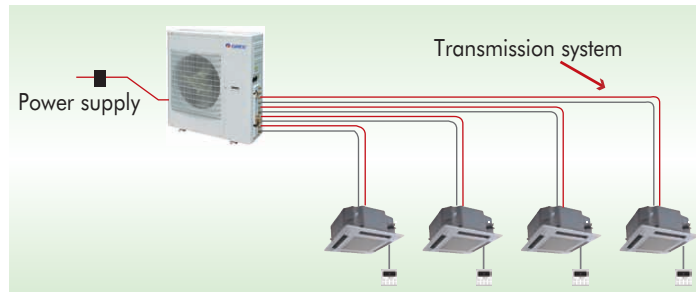

### ➔ High Lift Design

Equivalent pipe length of 80m and vertical lift of 15m is made possible with GWHD(42)NK3AO. Vertical lift between indoor units of 7.5m is the highest in the industry. This allows for greater flexibility in the location of the system. Please refer to chapter 5.2 for specific parameter.

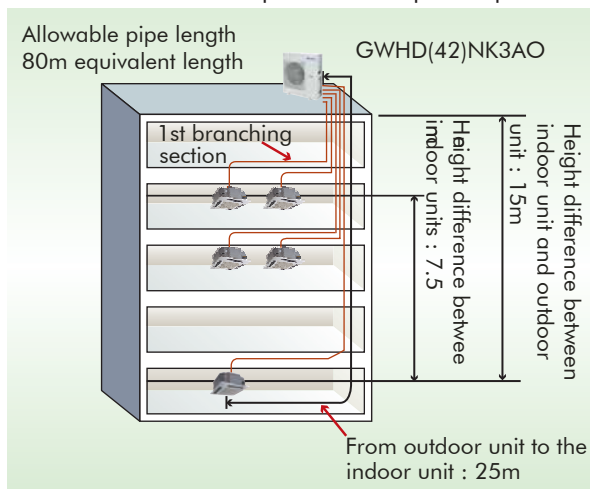

## ➔ Energy Saving

Because each room is controlled individually, only those rooms requiring air conditioning are cooled or heated. In addition, thanks to inverter technology, the level of air conditioning can be precisely controlled depending on the condition of each room. High EER is achieved by employing advanced technology, contributing to smooth and economical operation. The largest EER value can reach 3.2w/w, COP can reach 3.67w/w compared with the conventional chiller fan coil system, a large energy saving can be realized.

## ➔ Self Diagnostics System

Comprehensive troubleshooting code allows for finely identification of problems arising. Self diagnostics examples

Error code	Malfunction
E1	High pressure protection of compressor
E2	Indoor anti-frozen protection
E3	Low pressure protection of compressor
E4	Discharge temp. protection of compressor
E5	Compressor overload protection
E6	Communication error
E7	Modes conflict

## ➔ Compact Design

We offer a wide lineup of outdoor and indoor units to answered the needs of building size and interior design. The length of refrigerant pipes is layed without narrow on design, thus it allowing of flexibility more greater in planning. Indoor units are so lightweight and compact that they can be installed in any ceiling space. Outdoor units do not require the special cranes or conveyors to move them. They can even be hauled in a building elevator. the diameter of pipes is narrow, and the number is few, so making layout simpler. Inspection after installation is straightforward.

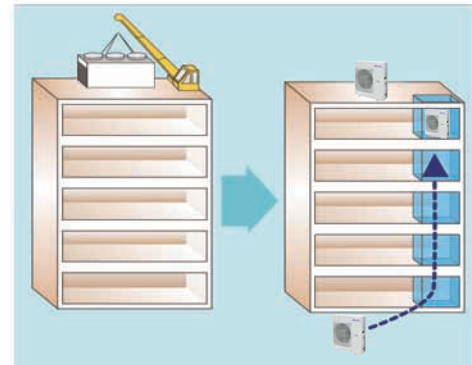

## ➔ Intelligent Control

GREE Free Match intelligent controls and modulating valves could deliver the required capacity, according to the load variation from 10% to 100%. the intelligent controls and modulating valves limit or increase the cooling modulating valves limit or increase the cooling capacity, so humidity and temperature are kept in the comfort range.

Electronic expansion valves respond to the changes in load of indoor units and continually control the flow rate of the refrigerant. In this way, we can get a nearly constant room temperature with the Free Match system without the typical temperature changes that occurs with a conventional ON/OFF control system. The extremely refined PID controls to maintains the room temperature within  $\pm 0.5^{\circ}\text{C}$  of the set temperature.

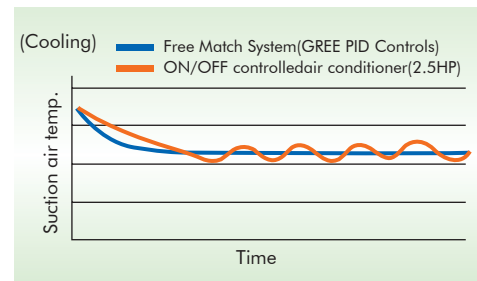

## **Refrigerant Recovery**

The Generation III Free Match System is able to recover the refrigerant automatically, which simplifies the refrigerant recovery operation and also is highly safe.

## **Adjustable Heating Capacity**

Under the low ambient heating ( below 0 °C ), the heating capacity of the system can be increased automatically to guarantee a reliable and sufficient heating effect.

## 2 SUMMARY OF SYSTEM EQUIPMENTS

### ➔ 2.1 Outdoor Unit

FREE MATCH III outdoor unit		
Model	GWHD(18)NK3FO	Appearance
Cooling Capacity (kW)	5.0	
Heating Capacity (kW)	5.6	

FREE MATCH III outdoor unit				
Model	GWHD(24)NK3FO	GWHD(24)NK3GO	GWHD(28)NK3FO	Appearance
Cooling Capacity (kW)	7.0	7.1	8.0	
Heating Capacity (kW)	7.7	8.5	9.3	

FREE MATCH III outdoor unit		
Model	GWHD(36)NK3BO	Appearance
Cooling Capacity (kW)	10.5	
Heating Capacity (kW)	11.0	

FREE MATCH III outdoor unit		
Model	GWHD(42)NK3AO	Appearance
Cooling Capacity (kW)	12.1	
Heating Capacity (kW)	13.0	

Conversion Formula: 1kW=3412Btu/h

## a. Nomenclature

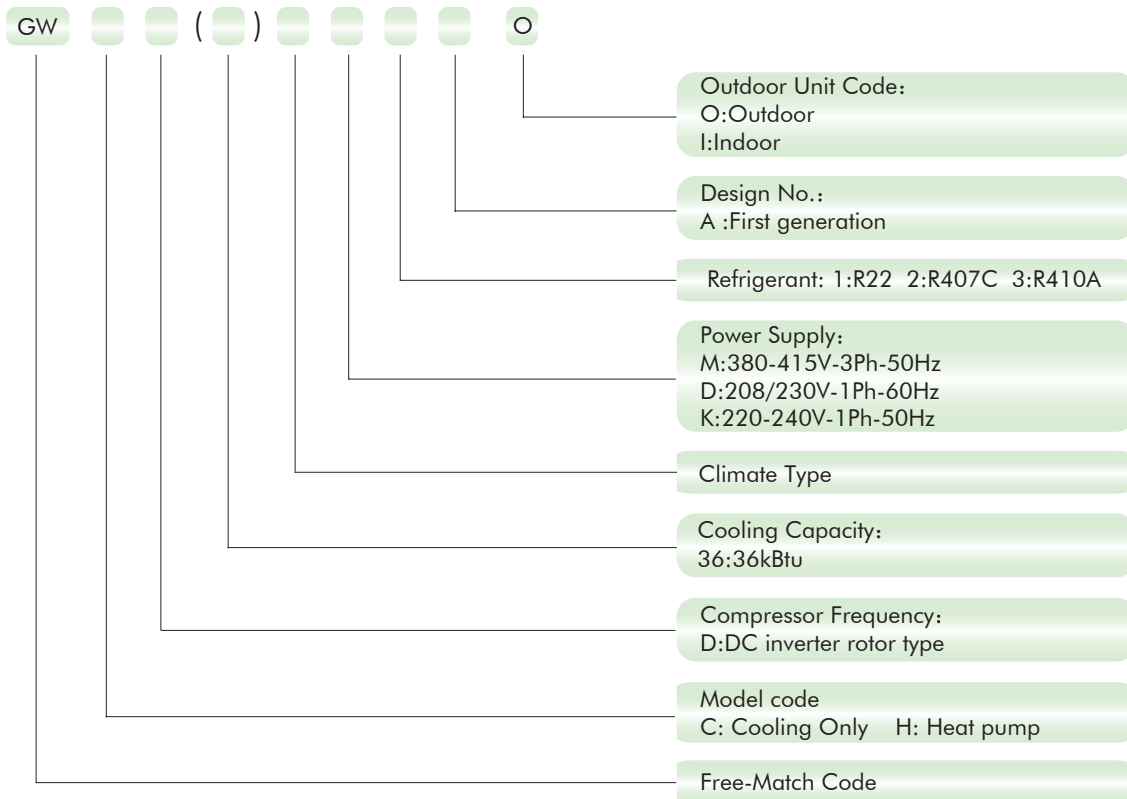

### Example:







GWHD(18)NK3FO: FREE MATCH III outdoor unit of GREE, with single compressor and the nominal cooling capacity is 5.0kW. The power supply is 220V~240V-1Ph-50Hz.

## b. Rated Conditions

**Cooling:** Indoor air temperature 27°C (80.6 °F )DB/19 °C (66.2 °F )WB  
 Outdoor air temperature 35 °C (95 °F )DB/24 °C (75.2 °F )WB

**Heating:** Indoor air temperature 20 °C (68 °F )DB/15 °C (59 °F )WB  
 Outdoor air temperature 7 °C (44.6 °F )DB/6 °C (42.8 °F )WB

## ➔ 2.2 Indoor Unit

Type	Appearance	Model Name	Capacity Code	Cooling Capacity(kW)	Heating Capacity(kW)
VIOLA		GWH(07)RA-K3DNA3E/I	7	2.1	2.6
		GWH(09)RA-K3DNA3E/I	9	2.6	2.8
		GWH(12)RB-K3DNA3E/I	12	3.5	3.8
		GWH(18)RC-K3DNA3E/I	18	5.3	5.8
Change		GWH(07)KF-K3DNA6E/I	7	2.1	2.6
		GWH(09)KF-K3DNA6E/I	9	2.6	2.8
		GWH(12)KF-K3DNA6E/I	12	3.5	3.8
		GWH(18)KG-K3DNA6E/I	18	5.3	5.8
Cozy		GWH(07)MA-K3DNA4E/I	7	2.1	2.6
		GWH(09)MA-K3DNA4E/I	9	2.6	2.8
		GWH(12)MB-K3DNA4E/I	12	3.5	3.8
		GWH(18)MC-K3DNA4E/I	18	5.3	5.8
Conceded Duct Standard Type		GFH(09)EA-K3DNA1A/I	9	2.5	2.8
		GFH(12)EA-K3DNA1A/I	12	3.5	3.85
		GFH(18)EA-K3DNA1A/I	18	5.0	5.5
		GFH(21)EA-K3DNA1A/I	21	6.0	6.6
		GFH(24)EA-K3DNA1A/I	24	7.1	8.0
4-way Air Discharge Cassette Type		GKH(12)BA-K3DNA1A/I	12	3.5	3.85
		GKH(18)BA-K3DNA1A/I	18	5.0	5.5
		GKH(24)BA-K3DNA1A/I	24	7.1	8.0
		GKH(12)BA-K3DNA2A/I	12	3.5	4.0
		GKH(18)BA-K3DNA2A/I	18	4.5	5.0
Flooring ceiling Type		GTH(09)BA-K3DNA1A/I	9	2.5	2.8
		GTH(12)BA-K3DNA1A/I	12	3.5	3.85
		GTH(18)BA-K3DNA1A/I	18	5.0	5.5
		GTH(24)BA-K3DNA1A/I	24	7.1	8.0

Conversion Formula: 1kW=3412Btu/h



## a. Nomenclature

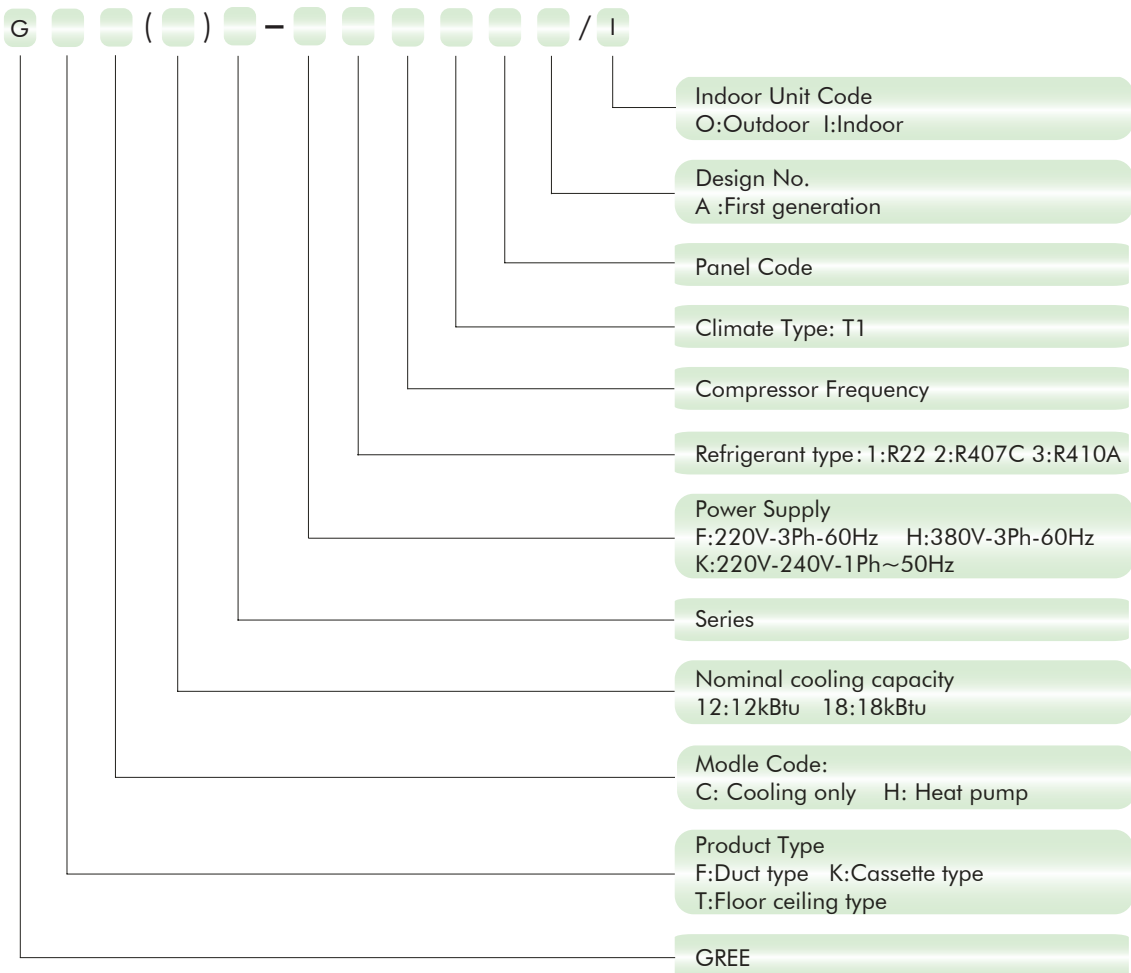

Example:



GFH(09)BA-K3DNA1A/I:A ducted type indoor unit of GREE, and the nominal cooling capacity is 2.5kW. It the R410A product. The power supply is 220V-240V-1Ph~50Hz.

## b. Rated Conditions

**Cooling:** Indoor air temperature 27°C (80.6 °F )DB/19 °C (66.2 °F )WB  
Outdoor air temperature 35 °C (95 °F )DB/24 °C (75.2 °F )WB

**Heating:** Indoor air temperature 20 °C (68 °F )DB/15 °C (59 °F )WB  
Outdoor air temperature 7 °C (44.6 °F )DB/6 °C (42.8 °F )WB

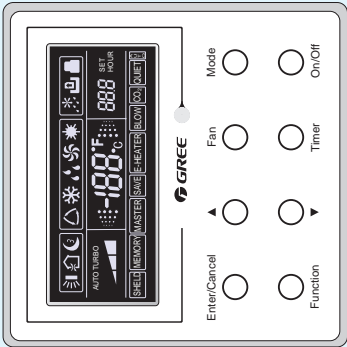
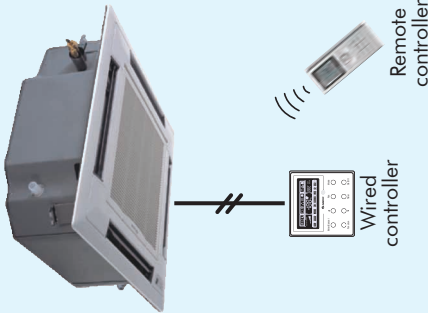
## ➔ 2.3 Controller

Name	Model Name	Appearance	Application	Function
Wired controller	XK19			<ul style="list-style-type: none"> <li>● Start/Stop</li> <li>● Mode changing</li> <li>● Temperature setting</li> <li>● Air flow changing</li> <li>● Timing setting</li> <li>● Self-diagnosis function</li> </ul> <p>Display codes of trouble.</p> <ul style="list-style-type: none"> <li>● Control by 2 remote controllers is available</li> </ul> <p>Two remote controllers can be connected to one indoor unit.              The indoor unit can be separately operated from the isolated places.</p>
Remote controller	YT1F			<ul style="list-style-type: none"> <li>● Start/Stop</li> <li>● Mode changing</li> <li>● Temperature setting</li> <li>● Air flow changing</li> <li>● Timing setting</li> </ul>

### 3 BASIC SYSTEM CONFIGURATION

#### System Legend (ex.)

Model name of outdoor unit:

GWHD(42)NK3AO

Allowed max. indoor unit:

5 Units

Allowed capacity code of indoor unit:

Min. : 9K Max. : 24K

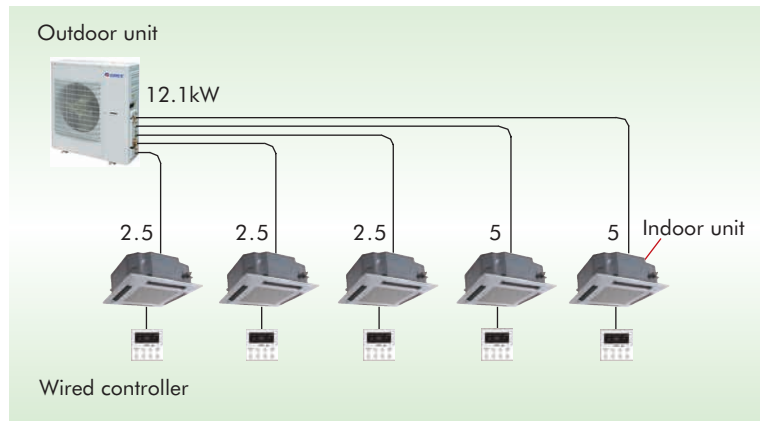

# 4 EQUIPMENT SELECTION PROCEDURE

## 4.1 Selection Flow Chart

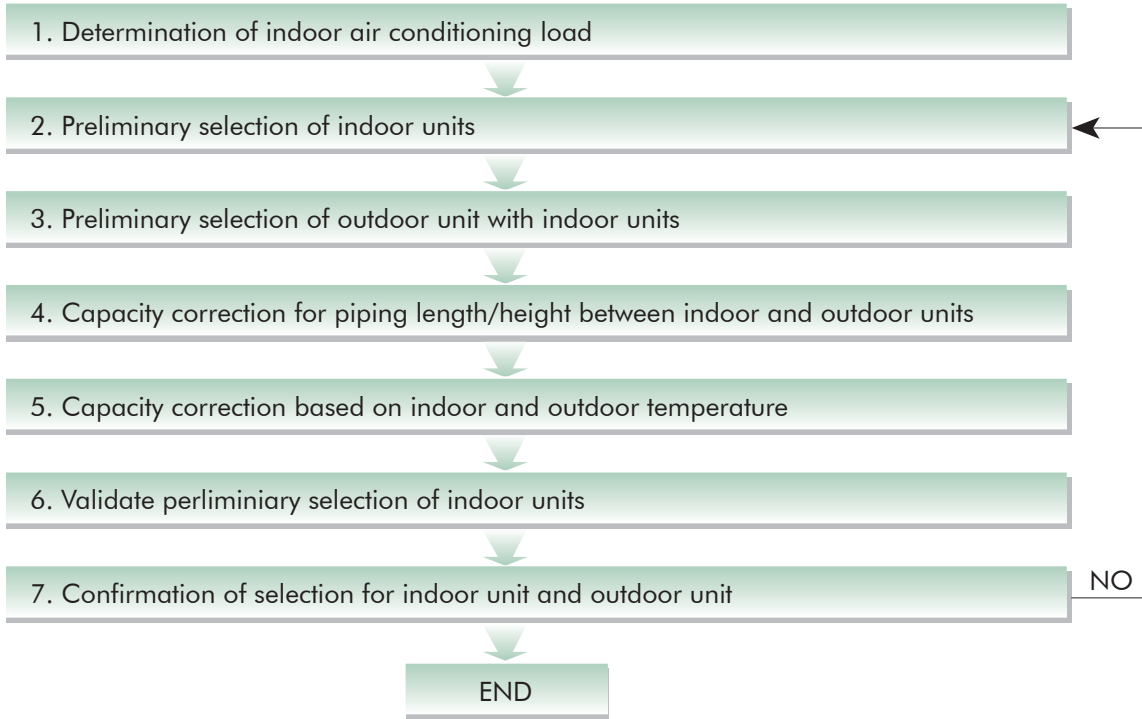

## 4.2 Combination Conditions for Indoor Unit and Outdoor Unit

- (1) The capacity code of indoor units = the nominal cooling capacity (Btu/h) × 1000.
- (2) For outdoor unit, maximum No. of connectable indoor units and total capacity code of indoor units are decided.

Model name of outdoor unit	Capacity code of outdoor unit	Max. No. of indoor units	Total capacity code of indoor units
GWHD(18)NK3FO	18	2	7 to 21
GWHD(24)NK3FO	24	2	14 to 30
GWHD(24)NK3GO	24	3	14 to 36
GWHD(28)NK3FO	28	4	14 to 42
GWHD(36)NK3BO	36	4	18 to 51.2
GWHD(42)NK3AO	42	5	21 to 63

## 4.3 Cooling/Heating Capacity Characteristics

### 4.3.1 Cooling Capacity Calculation Method

Required cooling capacity = cooling capacity × Factor ① × Factor ② kW

① Ambient Temperature vs. Capacity Correction Value

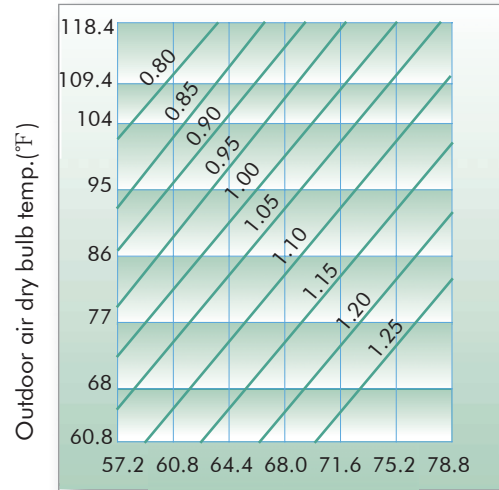
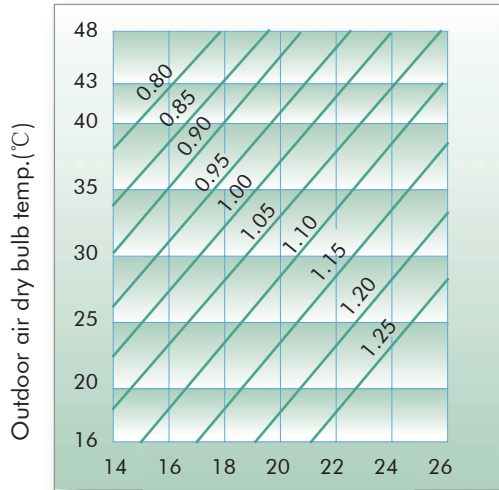

Indoor air wet bulb temp.(°C)

Indoor air wet bulb temp.(°F)

## ② Connecting Pipe Length and Height Difference Between Indoor and Outdoor Units vs. Capacity Correction Value

- ◆ Hp: Height Difference Between Indoor and Outdoor Units(Outdoor unit higher)
- ◆ Hm: Height Difference Between Indoor and Outdoor Units(Outdoor unit lower)
- ◆ L: Equivalent pipe length

**GWHD(36)NK3BO, GWHD(42)NK3AO**

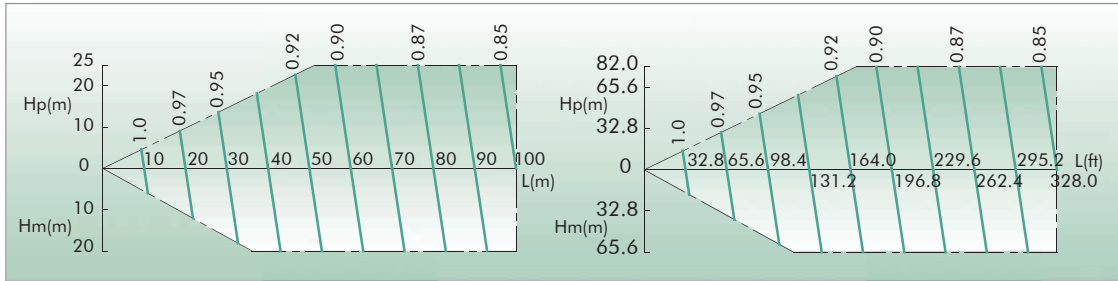

### 4.3.2 Heating Capacity Calculation Method

$$\text{Required Heating capacity} = \text{Heating capacity} \times \text{Factor ①} \times \text{Factor ②} \text{ kW}$$

## ① Ambient Temperature vs. Capacity Correction Value

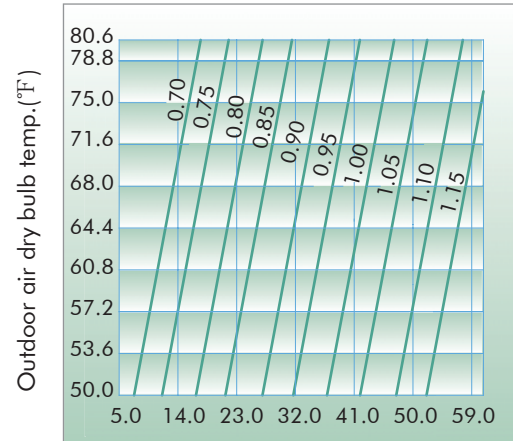
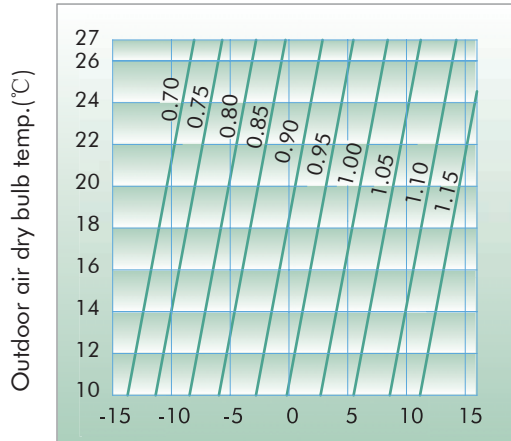

Indoor air wet bulb temp.(°C)

Indoor air wet bulb temp.(°F)

## ② Connecting Pipe Length Between Indoor and Outdoor Units vs. Capacity Correction Value

- ◆ Hp: Height Difference Between Indoor and Outdoor Units(Outdoor unit higher)
- ◆ Hm: Height Difference Between Indoor and Outdoor Units(Outdoor unit lower)
- ◆ L:Equivalent pipe length

**GWHD(36)NK3BO,GWHD(42)NK3AO**

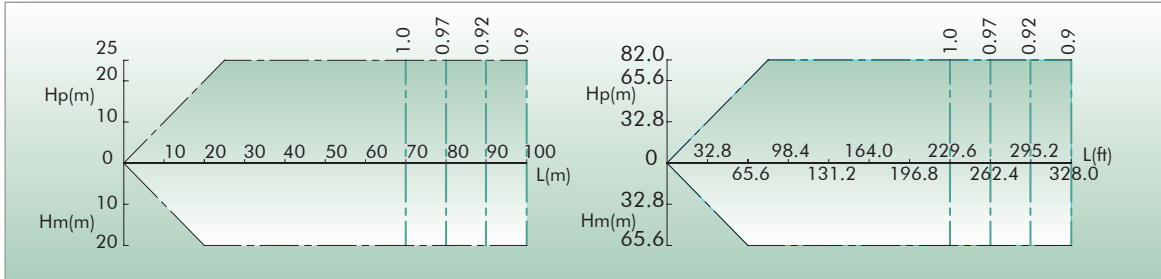

**4.3.3 Capacity Calculation for Each Indoor Unit**

Capacity for each indoor unit

$$= \text{Capacity after correction of outdoor unit} \times \frac{\text{Required standard capacity of indoor unit}}{\text{Total value of standard indoor unit capacity}}$$

**4.3.4 Operating temperature range**

Range	Mode	Outdoor temperature range °C ( °F )
	Cooling	-5~48°C (23~118.4 °F)
	Heating	-15~27°C (5~81 °F)

**➔ 4.4 Example of Equipment Selection**

**4.4.1 Overview of Building Model**

<Outside view>

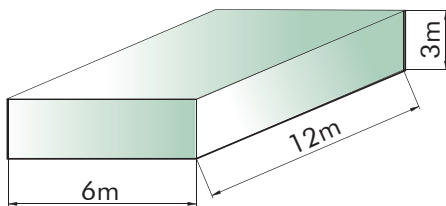

<Stories configuration>

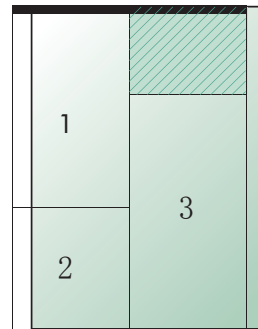

Non-air conditioning zone

Steel frame, reinforced concrete building, ten stories above ground.

**An apartment area : 72 m<sup>2</sup>**

Outdoor unit is installed on the balcony. Design indoor conditions:

**Cooling : 27.0°C (80.6 °F) / 19.0°C (66.2 °F) DB/WB**

Design outdoor conditions

**Cooling : 35°C (95 °F) DB (Standard condition)**

## 4.4.2 Selection Criteria for Each Apartment

Outdoor capacity exactly matches the total indoor capacity.

Total indoor HP = Outdoor unit HP

Indoor : 1.5 HP + 1HP + 2 HP = 4.5 HP

Outdoor : 5 HP (Same capacity)

## 4.4.3 Procedure and Result of Equipment Selection

### a. Procedure of Equipment Selection

- ① Calculate cooling for every rooms.
- ② Select an indoor unit to match the cooling load for every room.
- ③ Choose a tentative outdoor that will match with the indoor units. Perform capacity correction based on the pipe length, system lift, indoor set temperature, outdoor temperature. Then, make sure the corrected system cooling capacity satisfies the cooling load.

### b. Equipment Selection and Capacity Check

Air conditioning load			Equipment selection					
Floor	Room No.	Indoor cooling load (kW)	Indoor unit			Outdoor unit		
			Model	Capacity (kW)		Model	Capacity (kW)	
				Cooling	Heating		Cooling	Heating
5F	1	3.5	GFH(12)EA-K3DNA1A/I	3.5	3.85	GWHD(42)NK3AO	11.6	13.0
	2	2.5	GFH(09)EA-K3DNA1A/I	2.5	2.8			
	3	5	GFH(18)EA-K3DNA1A/I	5	5.5			

Conversion Formula: 1kW=3412Btu/h

Piping distance				Capacity correction		Capacity check after correction		
Floor	Room No.	Equivalent length (m)	Height Pipe difference (m)	correction x temp. correction		Capacity		Judgment
				Cooling	Heating	Capacity (kW)		
						Cooling	Heating	
5F	1	30	0	0.95	1	3.42	4.0	good
	2					2.375	3.0	
	3					4.75	5.8	

Conversion Formula: 1kW=3412Btu/h

### c. Schematic Diagram

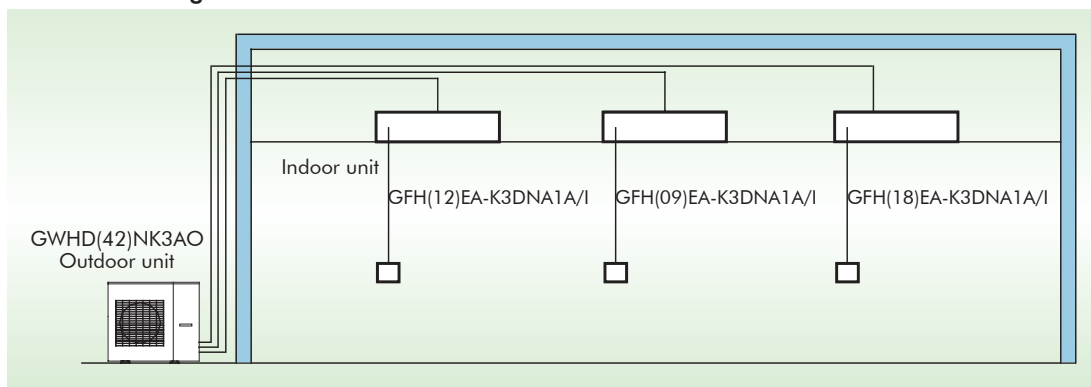

# 5 REFRIGERANT PIPING DESIGN

## ➔ 5.1 Warning on Refrigerant Leakage

The room in which the air conditioner is to be installed requires a design that in the event of refrigerant gas leaking out, its concentration will not exceed a set limit.

The refrigerant R410A which is used in the air conditioner is safe, without the toxicity or combustibility of ammonia. However, since it contains more than air, it poses the risk of suffocation if its concentration should rise excessively. Suffocation from leakage of R410A is almost non-existent. With the recent increase in the number of high concentration buildings, the installation of multi air conditioner systems is on the increase because of the need for effective use of floor space, individual control, energy conservation by curtailing heat and carrying power etc.

Most importantly, the multi air conditioner system is able to replenish a large amount of refrigerant compared with conventional individual air conditioners. If a single unit of the multi conditioner system is to be installed in a small room, select a suitable model and installation procedure so that if the refrigerant accidentally leaks out, its concentration does not reach the limit (and in the event of an emergency, measures can be made before injury can occur).

In a room where the concentration may exceed the limit, create an opening with adjacent rooms, or install mechanical ventilation combined with a gas leak detection device.

### 5.1.1 The Concentration Limit of R410A Which is Used in Multi Air Conditioner

The concentration limit of R410A which means the concentration limit of R410A that can be control by emergency measures to prevent human body from harming. The refrigerant concentration unit is  $kg/m^3$  (Which means the weight of refrigerant per  $m^3$  air ).

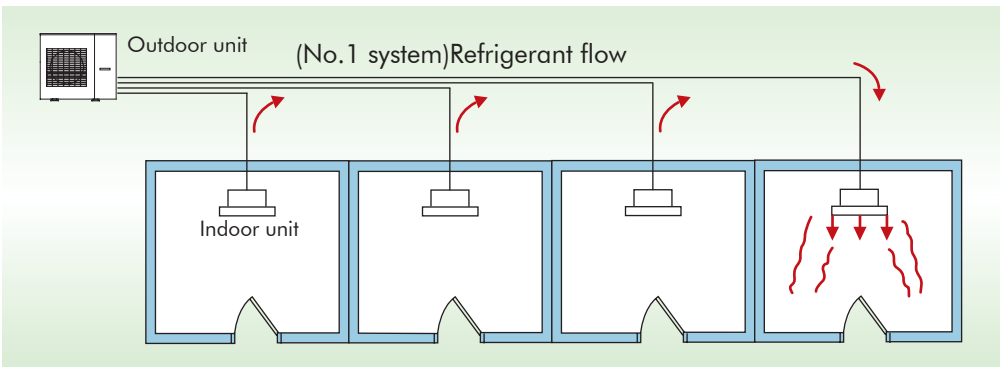

Fig.5.1

### 5.1.2 Check of Refrigerant Leakage

Calculate the refrigerant concentration as follows:

① Calculate the Amount of Refrigerant of Each Refrigeration System

[The amount of refrigerant of each system of outdoor unit] + [Additional charged amount at field installation]

Refrigerant amount of the outdoor unit at ex-factory

According to the liquid tube length and diameter

= System total amount of refrigerant(kg)

**NOTE:**

When single refrigeration system is consists of several independent refrigeration circuit, figure out the total refrigerant amount by each independent refrigerant circuit For the amount of charge in this example:



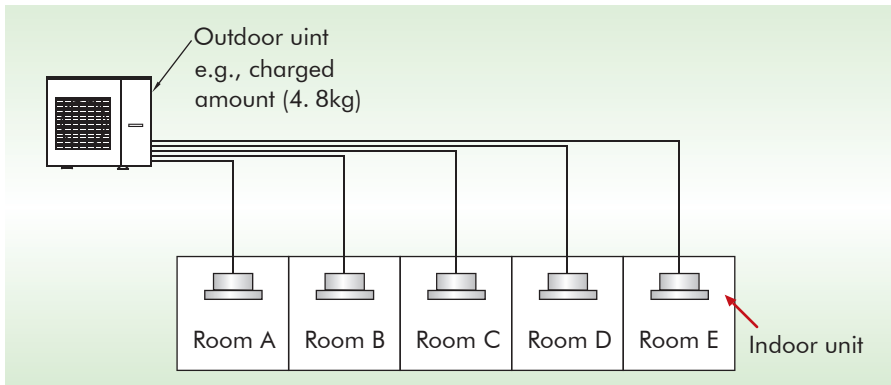

Fig.5.2

The possible amount of leaked refrigerant gas in rooms A, B, C, D and E is 4.8kg.  
 The possible amount of leaked refrigerant gas in rooms D, E is 7 kg.

② Calculate the Minimum Room Volume are as Follows

- ◆ No partition (shaded portion)

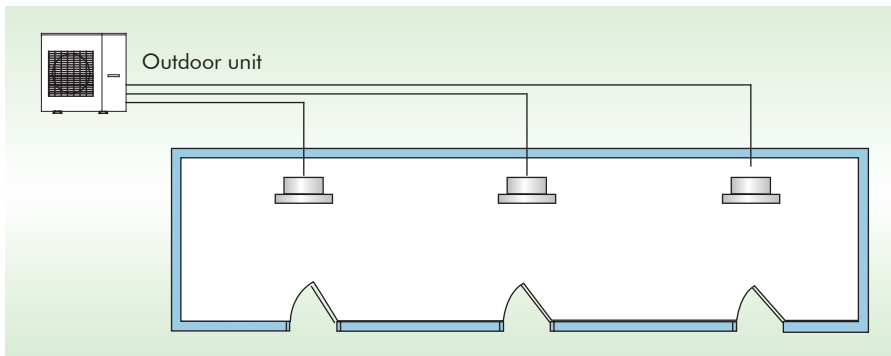

Fig.5.3

- ◆ When there is an effective opening with the adjacent room for ventilation of leaking refrigerant gas (opening with a door, or an opening 0.15% or larger than the respective floor spaces at the top or bottom of the door).

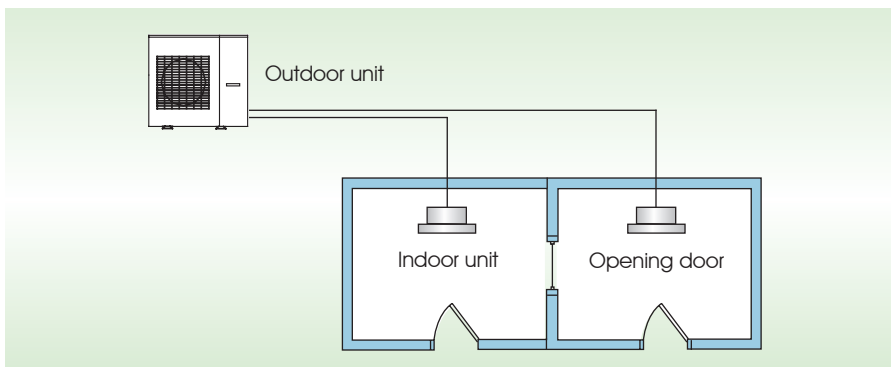

Fig.5.4

- ◆ If an indoor unit is installed in each partitioned room and the refrigerant tubing is interconnected, the smallest room of course becomes the object.

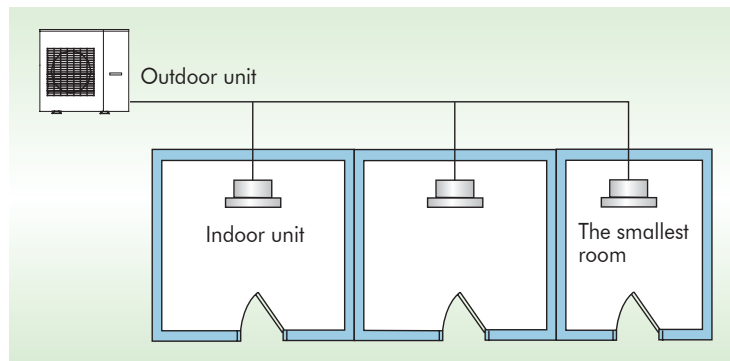

Fig.5.5

The concentration limit of R410A which is used in multi air conditioners is  $0.3\text{kg}/\text{m}^3$ .

③ Use the results of calculations ① and ② to calculate the refrigerant concentration:

The concentration is as given below:

$$\frac{\text{Total amount of refrigerant(kg)}}{\text{Min.volume of the indoor unit installed room(m}^3\text{)}} \leq \text{Concentration limit(kg/m}^3\text{)}$$

### 5.1.3 Measures When The Refrigerant Concentration Limit is Exceeded(JRA-GL 13-1998)

When the refrigerant concentration exceeds the density limit value relative to indoor volume, take proper actions according to following key points:

◆ **Method 1:** Set up an opening for efficient air exchange

Opening with a door, or an opening 0.1% or larger than the respective floor spaces at the top or bottom of the door.

◆ **Method 2:** Decrease the total amount of refrigerant in refrigerant equipment.

#### Shorten the Length of Refrigerant Pipe

Install the outdoor unit closer to the indoor unit and shorten the length of refrigerant pipe, hence to decrease the total amount of refrigerant in refrigerant equipment.

#### Decrease the Capacity of Outdoor Unit

Split the outdoor unit into multiple sets, thus decreasing the capacity of each outdoor unit to which one refrigerant system corresponds and hence to decrease the filling amount of refrigerant.

**For example:** If one 10HP system is split into 2 sets of 5HP systems, the amount of refrigerant in one refrigerant system may be half decreased approximately.

◆ **Method 3:** Set up an air exchange system

An air exchange system can be set to avoid too high concentration of refrigerant in event of refrigerant leakage. The air exchange system includes two types, i.e. external air import and air discharge. From the property of refrigerant, it is recommended to adopt the external air import.

#### Exchanging Air Volume

According to the total amount of refrigerant of refrigerant equipment and the room volume, air exchange volume should be greater than the volume showed in Fig.5.6.

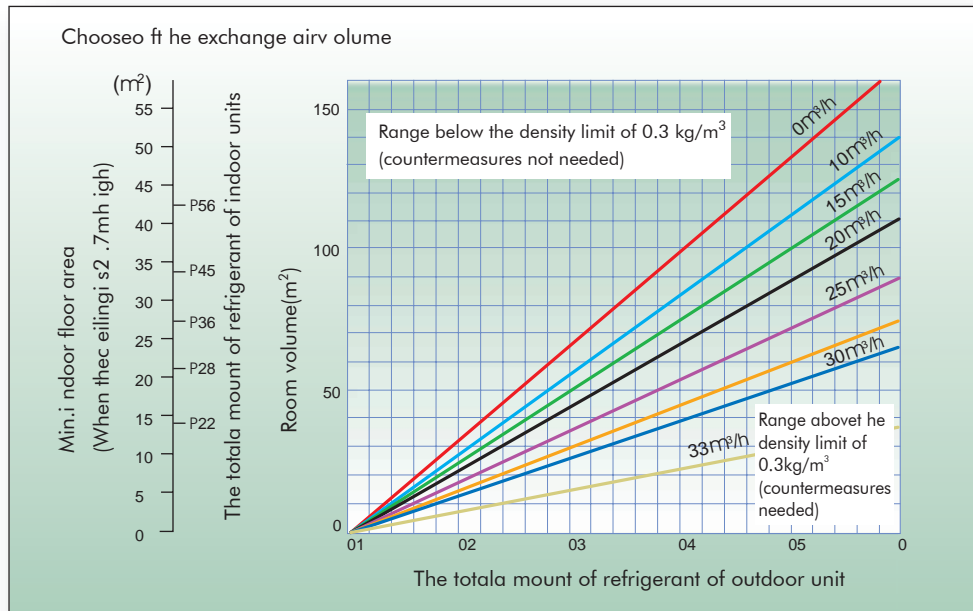

Fig.5.6

### Detector and Interlink

In principle, the air exchange system shall always work normally no matter the air conditioner is used or any person stays in the room. If it is impossible to realize long-term working, please use a detector system to activate the air exchange system upon leakage of refrigerant. Shown in Fig. 5.7 is the air exchange system in long-term working. Shown in Fig. 5.8 is the detector interlink system.

**NOTE:**

- (a) In order to avoid malfunction of air exchange system, please do not choose the range showed in oblique line in Fig. 5.6 even though equipped with air exchange system. If entering into this range, should set effective air exchange port, expand room volume or decrease the amount of outdoor unit, change the piping length in order to decrease total refrigerant amount, in principle according to method 1 and 2.
- (b) Where an air exchange system is provided but it is impossible to take Method 1 or Method 2 when the refrigerant concentration is within the range indicated by the oblique line in Fig. 5.6, please use other means independent from air exchange system to ensure safety. In detail, we can set a refrigerant cutoff valve that can be activated by the detector upon refrigerant leakage and as well, set an alarm system that can notify the indoor person. The detector here is different from the detector in aforementioned air exchange system. Shown in Fig. 5.9 is the status that a refrigerant cutoff valve is set.
- (c) To set an air exchange system, please ensure to leave an efficient air exchange gap (e.g. gap below the door) at the lowest part of the room.
- (d) For connection of pipes within living area, please make sure to comply with JIS specification and perform thorough airtight test after the work is completed. Additionally, please ensure that the pipe is installed with shockproof device to avoid damage due to earthquake or the other external forces. (But on axial direction, a leeway shall be left to eliminate the stress caused by temperature variation).

**Long Term Working Air Exchange System**

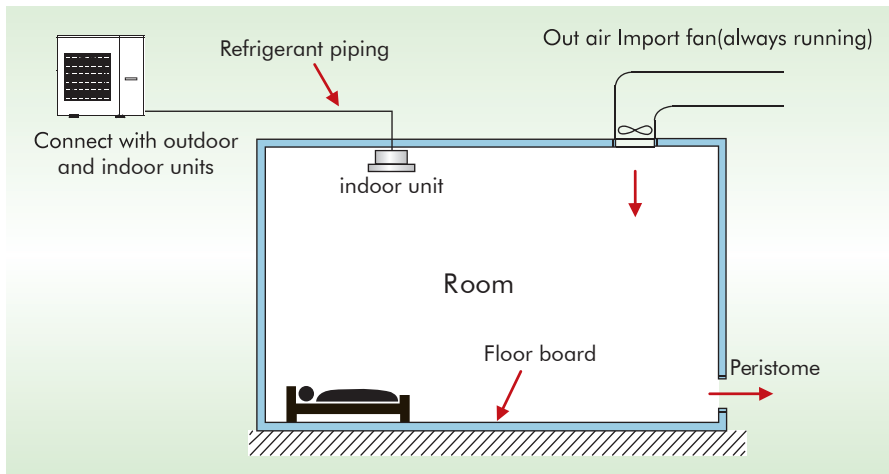

Fig.5.7

**Detector Interlink System**

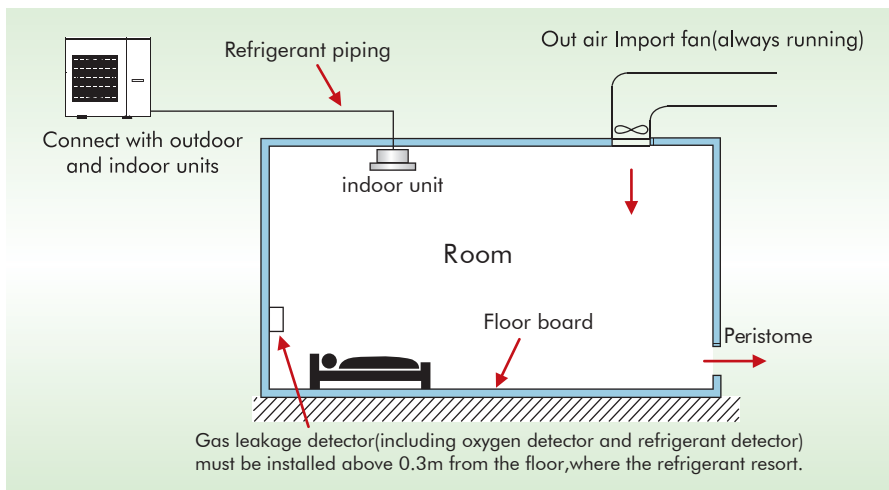

Fig.5.8

**Position of Long Term Running Ventilation System and Refrigerant Cut-off Valve**

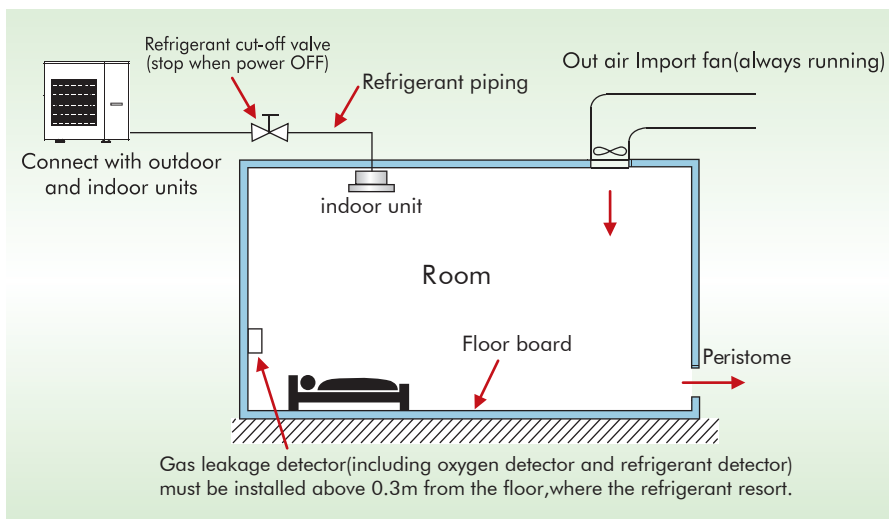

Fig.5.9

## ➔ 5.2 Allowable Length/Height Difference of Refrigerant Piping

### GWHD(18)NK3FO,GWHD(24)NK3FO

		Allowable Length		Refrigerant Pipe	
		GWHD(18)NK3FO	GWHD(24)NK3FO	GWHD(18)NK3FO	GWHD(24)NK3FO
Max. Total Liquid Pipe Length (m)		20	20	L1+L2	L1+L2
Max. Not Additional Gas Total Liquid Pipe Length(m)		10	10	-	
Max. Length for Single Unit (m)		10	10	L1	
Max. installation altitude	Outdoor unit and indoor unit	5	5	H1	
	Indoor unit and indoor unit	7.5	7.5	H2	

### GWHD(24)NK3GO,GWHD(28)NK3FO

		Allowable Length		Refrigerant Pipe	
		GWHD(24)NK3GO	GWHD(28)NK3FO	GWHD(24)NK3GO	GWHD(28)NK3FO
Max. Total Liquid Pipe Length (m)		60	70	L1+L2+L3	L1+L2+L3+ L4
Max. Not Additional Gas Total Liquid Pipe Length(m)		15	20	-	
Max. Length for Single Unit (m)		20	20	L1	
Max. installation altitude	Outdoor unit and indoor unit	10	10	H1	
	Indoor unit and indoor unit	7.5	7.5	H2	

### GWHD(36)NK3BO,GWHD(42)NK3AO

		Allowable Length		Refrigerant Pipe	
		GWHD(36)NK3BO	GWHD(42)NK3AO	GWHD(36)NK3BO	GWHD(42)NK3AO
Max. Total Liquid Pipe Length (m)		70	80	L1+L2+L3+ L4	L1+L2+L3+ L4+ L5
Max. Not Additional Gas Total Liquid Pipe Length(m)		40	50	-	
Max. Length for Single Unit (m)		20	25	L1	
Max. installation altitude	Outdoor unit and indoor unit	15	15	H1	
	Indoor unit and indoor unit	7.5	7.5	H2	

Additional Refrigerant Charge=∑Extra Liquid Pipe Length×22g/m(liquid pipe 1/4").

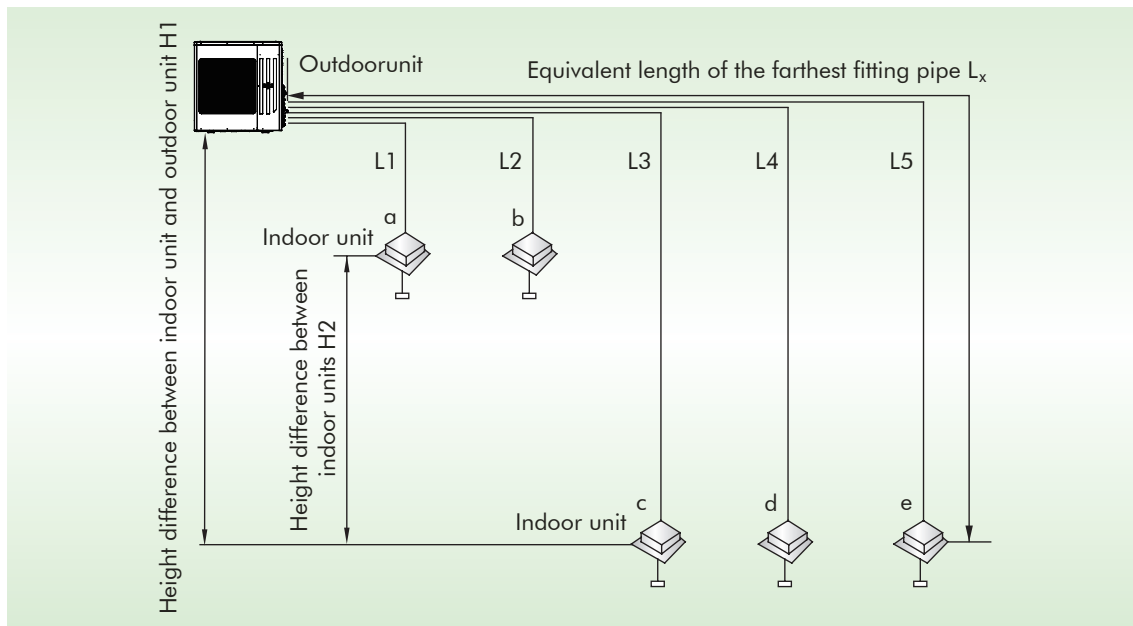

If the specification of the outdoor unit pipe joint does not conform to that of the indoor unit, then the joint specification of the outlet pipe of the indoor unit takes precedence. A reducing nipple shall be installed at the joint of the outdoor unit so as to make the joint of the outdoor unit compatible with that of the indoor unit.



### 5.3 Charging equipment with Additional RRefrigerant

#### Refrigerant in the System When Shipped from the Factory

Model name	GWHD(18)NK3FO	GWHD(24)NK3FO
Refrigerant amount charged in factory	1.4kg	2.0kg
Model name	GWHD(24)NK3GO	GWHD(28)NK3FO
Refrigerant amount charged in factory	2.2kg	2.2kg
Model name	GWHD(36)NK3BO	GWHD(42)NK3AO
Refrigerant amount charged in factory	4.3kg	4.8kg

#### NOTE:

- The refrigerant charge mentioned in the table above is not included those charged additionally in the indoor unit and the refrigerant pipe.
- The amount of the additional refrigerant charge is dependent on the diameter and length of the liquid refrigerant pipe which is decided by the actual yield installation requirement.
- Record the additional refrigerant charge for future maintenance.

## 6 WIRING DESIGN

### 6.1 General

- (1) Perform wiring of the power supply in conformance with the regulations of the local electric company.
- (2) For the control wires connecting indoor units, and between indoor and outdoor units, use of twisted pair shield wires is recommended to prevent noise trouble.
- (3) Be sure to set the earth leakage breaker and the switches to the power supply section of the indoor unit.
- (4) Supply power to each outdoor unit and provide an earth leakage breaker or hand switch for each outdoor unit.
- (5) Store wiring system for control and refrigerant piping system in the same line.
- (6) Arrange the cables so that the electric wires do not contact with high-temperature part of the pipe; otherwise coating melts and an accident may be caused.
- (7) Do not turn on power of the indoor unit until vacuuming of the refrigerant pipe finish.

### 6.2 Electrical Wiring Design

#### 6.2.1 Wiring Drawing

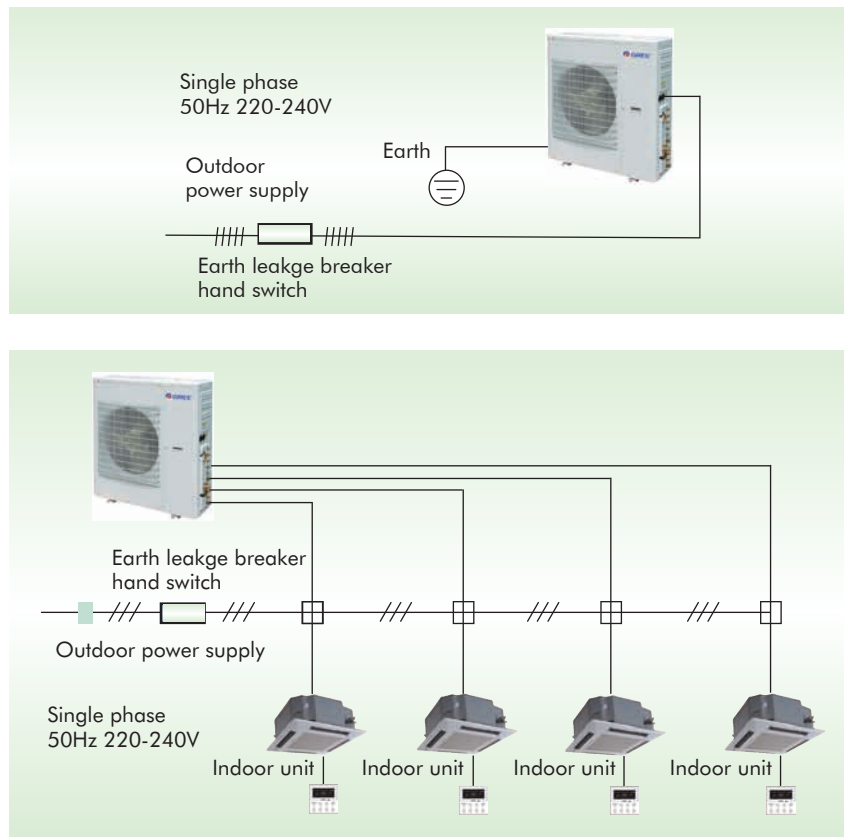

### 6.2.2 Selection of Power Supply Cabling and Fuse of Units

Model		Power supply wiring	
		Wire Size	Field Fuse
Outdoor Unit	GWHD(18)NK3FO	2.5mm <sup>2</sup>	25A
	GWHD(24)NK3FO	2.5mm <sup>2</sup>	30A
	GWHD(24)NK3GO	2.5mm <sup>2</sup>	30A
	GWHD(28)NK3FO	2.5mm <sup>2</sup>	30A
	GWHD(36)NK3BO	4mm <sup>2</sup>	32A
	GWHD(42)NK3AO	4mm <sup>2</sup>	32A
Indoor Unit	All models of indoor units	1.5mm <sup>2</sup>	10A

- ◆ Determine the wire size for indoor unit according to the number of connected indoor units downstream.
- ◆ Observe local regulation regarding wire size selection and installation.

**NOTE :**

The specification of power cord mentioned hereby is defined as the required specification when wiring with BV single core cable (2~4 pieces) under the cover of PVC pipe, and environment temperature shall be at 40°C ; Air switch shall be selected according to 40°C temperature condition, and shall in D type. if the installation condition on site changed, please consider the modification on the required specification of Power cord and Air switch, according to the specification manual provided by manufacture.

**! CAUTIONS**

- (1) Keep the refrigerant piping system and the indoor-indoor/indoor-outdoor control wiring systems together.
- (2) When running power wires and control wires parallel to each other. either run them through separate conduits or (Current capacity of power wires: 10A or less for 300m, 50A or less for 500m) .

## ➔ 6.3 Parameters

### 6.3.1 Outdoor Unit

Model name	Voltage Range		Compressor	Fan Motor	
	Min	Max		kW	FLA
GWHD(18)NK3FO	198	264	7.2A	0.06	0.56
GWHD(24)NK3FO	198	264	11.5A	0.06	0.06
GWHD(24)NK3GO	198	264	11.5A	0.06	0.06
GWHD(28)NK3FO	198	264	11.5A	0.09	0.06
GWHD(36)NK3BO	198	264	14.0A	0.17	0.95A
GWHD(42)NK3AO	198	264	13.5A	0.14	1.1A

**LEGEND:**

MCA: **Minimum Circuit Amps**

FLA: **Full Load Amps**

kW: **Fan Motor Rated Output(kW)**

RLA: **Rated Load Amps**

**Note:** RLA is based on the following conditions.

Indoor temperature: **29°C (84.2F)DB/19°C (66.6F)WB**

Outdoor temperature: **46°C (114.8F) DB**



**6.3.2 Indoor Unit**

Type	Model name	Nominal Voltage (V/Ph/Hz)	Voltage Range		Fan Motor	
			Min	Max	kW	FLA
VIOLA	GWH(07)RA-K3DNA3E/I	220-240/1/50	198	264	0.01	0.144A
	GWH(09)RA-K3DNA3E/I				0.01	0.144A
	GWH(12)RB-K3DNA3E/I				0.02	0.22A
	GWH(18)RC-K3DNA3E/I				0.02	0.31A
Cozy	GWH(07)MA-K3DNA4E/I	220-240/1/50	198	264	0.01	0.144A
	GWH(09)MA-K3DNA4E/I				0.01	0.144A
	GWH(12)MB-K3DNA4E/I				0.02	0.22A
	GWH(18)MC-K3DNA4E/I				0.02	0.31A
Change	GWH(07)KF-K3DNA6E/I	220-240/1/50	198	264	0.01	0.16A
	GWH(09)KF-K3DNA6E/I				0.01	0.16A
	GWH(12)KF-K3DNA6E/I				0.01	0.16A
	GWH(18)KG-K3DNA6E/I				0.02	0.31A
Duct type	GFH(09)EA-K3DNA1A/I	220-240/1/50	198	264	0.078	0.28A
	GFH(12)EA-K3DNA1A/I				0.1	0.31A
	GFH(18)EA-K3DNA1A/I				0.11	0.41A
	GFH(21)EA-K3DNA1A/I				0.08	0.5A
	GFH(24)EA-K3DNA1A/I				0.08	0.5A
4-way Air Discharge Cassette Type	GKH(12)BA-K3DNA1A/I	220-240/1/50	198	264	0.08	0.32A
	GKH(18)BA-K3DNA1A/I				0.08	0.32A
	GKH(24)BA-K3DNA1A/I				0.1	0.43A
	GKH(12)BA-K3DNA2A/I	220-240/1/50	198	264	0.05	0.2A
	GKH(18)BA-K3DNA2A/I				0.05	0.2A
Flooring Ceiling Type	GTH(09)BA-K3DNA1A/I	220-240/1/50	198	264	0.04	0.28A
	GTH(12)BA-K3DNA1A/I				0.05	0.28A
	GTH(18)BA-K3DNA1A/I				0.08	0.5A
	GTH(24)BA-K3DNA1A/I				0.11	0.5A

**LEGEND:**

FLA: Full Load Amps

kW: Fan Motor Rated Output(kW)

# 7 ACCESSORIES

## 7.1 Outdoor Unit

Accessories model name	Standard	Option	Field supplied
Power Cable			√
Flexible pipe	√		

## 7.2 Indoor Unit

Accessories model name	Standard	Option	Field supplied
Power Cable			√
Wireless Remote Controller	√		
Wired Controller	√		
Connecting Cable for Wired Controller (8m)	√		
Drain Pipe	√		

## 7.3 Controller

Accessories name	Model name	Standard	Option	Remark
Wireless Remote Controller	YT1F	√		Common parts for all type model

## 8 TECHNICAL SPECIFICATIONS

### ➔ 8.1 Indoor Unit

#### ◆ VIOLA

Indoor Unit		Model	GWH(07)RA-K3DNA3E/I	GWH(09)RA-K3DNA3E/I
Electrical Data	Power supply	V-Hz-Ph	220-240-50-1	220-240-50-1
Sound Pressure Level (H/M/L)		dB (A)	37/35/32	37/35/32
Air Flow Volume(rated EXP)		CFM	247	247
Fan Motor	Drive Type	-	Direct drive	Direct drive
	Power Output	W	10	10
	Full Load Amp(FLA)	A	0.144	0.144
Drainage Connection Size		mm	16	16
Dimension	Outline(W×D×H)	mm	794×186×265	794×186×265
	Package(L×W×H)	mm	873×353×270	873×353×270
Weight	Net/Gross	kg	9.0/11.5	9.0/11.5
Loading quantity (within panel)		20'GP	366	366
		40'GP	756	756
		40'HQ	840	840

#### NOTES:

- The technical parameters are changed along with the products,improvement; please refer to the nameplate of the unit for actual data.
- The Heating capacity of the heat pump type is the capacity of heat pump.
- Noise is tested in the semi-anechoic room, so it should be slightly higher in the actual operation due to the environ-mental change.
- Rated conditions: Cooling : Indoor air temperature 27°C (80.6 °F ) DB/19°C (66.2 °F ) WB,  
Outdoor air temperature 35°C (95 °F ) DB/24°C (75.2 °F ) WB,  
Heating : Indoor air temperature 20°C (68 °F ) DB/15°C (59 °F ) WB,  
Outdoor air temperature 7°C (44.6 °F ) DB/6°C (42.8 °F ) WB.

Indoor Unit		Model	GWH(12)RB-K3DNA3E/I	GWH(18)RC-K3DNA3E/I
Electrical Data	Power supply	V-Hz-Ph	220-240-50-1	220-240-50-1
Sound Pressure Level (H/M/L)		dB (A)	39/36/33	42/37/33
Air Flow Volume(rated EXP)		CFM	312	459
Fan Motor	Drive Type	-	Direct drive	Direct drive
	Power Output	W	20	20
	Full Load Amp(FLA)	A	0.22	0.31
Drainage Connection Size		mm	16	16
Dimension	Outline(W×D×H)	mm	848×189×274	945×208×298
	Package(L×W×H)	mm	926×359×279	1013×383×300
Weight	Net/Gross	kg	10.0/12.5	13.0/16.0
Loading quantity (within panel)		20'GP	306	254
		40'GP	636	541
		40'HQ	742	609

**NOTES:**

- a. The technical parameters are changed along with the products,improvement; please refer to the nameplate of the unit for actual data.
- b. The Heating capacity of the heat pump type is the capacity of heat pump.
- c. Noise is tested in the semi-anechoic room, so it should be slightly higher in the actual operation due to the environ-mental change.
- d. Rated conditions: Cooling : Indoor air temperature 27°C (80.6 °F ) DB/19°C (66.2 °F ) WB,  
Outdoor air temperature 35°C (95 °F ) DB/24°C (75.2 °F ) WB.  
Heating : Indoor air temperature 20°C (68 °F ) DB/15°C (59 °F ) WB,  
Outdoor air temperature 7°C (44.6 °F ) DB/6°C (42.8 °F ) WB.

## ◆ Cozy

Indoor Unit		Model	GWH(07)MA-K3DNA4E/I	GWH(09)MA-K3DNA4E/I
Electrical Data	Power supply	V-Hz-Ph	220-240-50-1	220-240-50-1
Sound Pressure Level (H/M/L)		dB (A)	34/31/28	34/31/28
Air Flow Volume(rated EXP)		CFM	241	241
Fan Motor	Drive Type	-	Direct drive	Direct drive
	Power Output	W	10	10
	Full Load Amp(FLA)	A	0.144	0.144
Drainage Connection Size		mm	16	16
Dimension	Outline(W×D×H)	mm	790×170×265	790×170×265
	Package(L×W×H)	mm	873×251×370	873×251×370
Weight	Net/Gross	kg	9.0/11.0	9.0/11.0
Loading quantity (within panel)		20'GP	348	348
		40'GP	732	732
		40'HQ	852	852

### NOTES:

- The technical parameters are changed along with the products,improvement; please refer to the nameplate of the unit for actual data.
- The Heating capacity of the heat pump type is the capacity of heat pump.
- Noise is tested in the semi-anechoic room, so it should be slightly higher in the actual operation due to the environ-mental change.
- Rated conditions: Cooling : Indoor air temperature 27°C (80.6 °F ) DB/19°C (66.2 °F ) WB,  
Outdoor air temperature 35°C (95 °F ) DB/24°C (75.2 °F ) WB.  
Heating : Indoor air temperature 20°C (68 °F ) DB/15°C (59 °F ) WB,  
Outdoor air temperature 7°C (44.6 °F ) DB/6°C (42.8 °F ) WB.

Indoor Unit		Model	GWH(12)MB-K3DNA4E/I	GWH(18)MC-K3DNA4E/I
Electrical Data	Power supply	V-Hz-Ph	220-240-50-1	220-240-50-1
Sound Pressure Level (H/M/L)		dB (A)	34/32/30	43/40/36
Air Flow Volume(rated EXP)		CFM	294	459
Fan Motor	Drive Type	-	Direct drive	Direct drive
	Power Output	W	20	20
	Full Load Amp(FLA)	A	0.22	0.31
Drainage Connection Size		mm	16	16
Dimension	Outline(W×D×H)	mm	845×180×275	940×200×298
	Package(L×W×H)	mm	918×258×370	1013×288×395
Weight	Net/Gross	kg	10.0/12.5	13.0/16.0
Loading quantity (within panel)		20'GP	336	254
		40'GP	684	541
		40'HQ	798	609

**NOTES:**

- a. The technical parameters are changed along with the products,improvement; please refer to the nameplate of the unit for actual data.
- b. The Heating capacity of the heat pump type is the capacity of heat pump.
- c. Noise is tested in the semi-anechoic room, so it should be slightly higher in the actual operation due to the environ-mental change.
- d. Rated conditions: Cooling : Indoor air temperature 27°C (80.6 °F ) DB/19°C (66.2 °F ) WB,  
Outdoor air temperature 35°C (95 °F ) DB/24°C (75.2 °F ) WB.  
Heating : Indoor air temperature 20°C (68 °F ) DB/15°C (59 °F ) WB,  
Outdoor air temperature 7°C (44.6 °F ) DB/6°C (42.8 °F ) WB.

## ◆ Change

Indoor Unit		Model	GWH(07)KF-K3DNA6E/I	GWH(09)KF-K3DNA6E/I
Electrical Data	Power supply	V-Hz-Ph	220-240-50-1	220-240-50-1
Sound Pressure Level (H/M/L)		dB (A)	38/30/24	38/30/24
Air Flow Volume(rated EXP)		CFM	306	306
Fan Motor	Drive Type	-	Direct drive	Direct drive
	Power Output	W	10	10
	Full Load Amp(FLA)	A	0.16	0.16
Drainage Connection Size		mm	16	16
Dimension	Outline(W×D×H)	mm	770×201×283	770×201×283
	Package(L×W×H)	mm	847×264×357	847×264×357
Weight	Net/Gross	kg	8.0/10.0	8.0/10.0
Loading quantity (within panel)		20'GP	342	336
		40'GP	712	696
		40'HQ	803	783

### NOTES:

- The technical parameters are changed along with the products,improvement; please refer to the nameplate of the unit for actual data.
- The Heating capacity of the heat pump type is the capacity of heat pump.
- Noise is tested in the semi-anechoic room, so it should be slightly higher in the actual operation due to the environ-mental change.
- Rated conditions: Cooling : Indoor air temperature 27°C (80.6 °F ) DB/19°C (66.2 °F ) WB,  
Outdoor air temperature 35°C (95 °F ) DB/24°C (75.2 °F ) WB.  
Heating : Indoor air temperature 20°C (68 °F ) DB/15°C (59 °F ) WB,  
Outdoor air temperature 7°C (44.6 °F ) DB/6°C (42.8 °F ) WB.

Indoor Unit		Model	GWH(12)KF-K3DNA6E/I	GWH(18)KG-K3DNA6E/I
Electrical Data	Power supply	V-Hz-Ph	220-240-50-1	220-240-50-1
Sound Pressure Level (H/M/L)		dB (A)	39/31/25	40/37/32
Air Flow Volume(rated EXP)		CFM	329	400
Fan Motor	Drive Type	-	Direct drive	Direct drive
	Power Output	W	10	20
	Full Load Amp(FLA)	A	0.16	0.31
Drainage Connection Size		mm	16	16
Dimension	Outline(W×D×H)	mm	770×201×283	865×215×305
	Package(L×W×H)	mm	847×264×357	948×298×395
Weight	Net/Gross	kg	9.0/11.0	12.0/15.0
Loading quantity (within panel)		20'GP	336	264
		40'GP	696	542
		40'HQ	783	616

**NOTES:**

- a. The technical parameters are changed along with the products,improvement; please refer to the nameplate of the unit for actual data.
- b. The Heating capacity of the heat pump type is the capacity of heat pump.
- c. Noise is tested in the semi-anechoic room, so it should be slightly higher in the actual operation due to the environ-mental change.
- d. Rated conditions: Cooling : Indoor air temperature 27°C (80.6 °F ) DB/19°C (66.2 °F ) WB,  
Outdoor air temperature 35°C (95 °F ) DB/24°C (75.2 °F ) WB.  
Heating : Indoor air temperature 20°C (68 °F ) DB/15°C (59 °F ) WB,  
Outdoor air temperature 7°C (44.6 °F ) DB/6°C (42.8 °F ) WB.



## ◆ Duct Type

Model			GFH(09)EA-K3DNA1A/I	GFH(12)EA-K3DNA1A/I	GFH(18)EA-K3DNA1A/I
Electrical Data	Power supply	V-Hz-Ph	220-240-50-1	220-240-50-1	220-240-50-1
	Sound Pressure Level (H/L)	dB (A)	37/31	39/32	41/33
Air Flow Volume(rated EXP)		CFM	265	294	412
Fan Motor	Drive Type	-	directly drive	directly drive	directly drive
	Power Output	W	30	40	60
	Full Load Amp(FLA)	A	0.28	0.31	0.41
Drainage Connection Size		mm	26	26	26
Dimension	Outline(W×D×H)	mm	700×615×200	700×615×200	900×615×200
	Package(L×W×H)	mm	893×743×305	893×743×305	1123×743×305
Weight	Net/Gross	kg	22.0/27.0	23.0/29.0	27.0/36.0
Loading quantity (within panel)		20'GP	108	108	90
		40'GP	234	234	180
		40'HQ	234	234	180

### NOTES:

- The technical parameters are changed along with the products,improvement; please refer to the nameplate of the unit for actual data.
- The Heating capacity of the heat pump type is the capacity of heat pump.
- Noise is tested in the semi-anechoic room, so it should be slightly higher in the actual operation due to the environ-mental change.
- Rated conditions: Cooling : Indoor air temperature 27°C (80.6 °F ) DB/19°C (66.2 °F ) WB,  
Outdoor air temperature 35°C (95 °F ) DB/24°C (75.2 °F ) WB.  
Heating : Indoor air temperature 20°C (68 °F ) DB/15°C (59 °F ) WB,  
Outdoor air temperature 7°C (44.6 °F ) DB/6°C (42.8 °F ) WB.

Model			GFH(21)EA-K3DNA1A/I	GFH(24)EA-K3DNA1A/I
Electrical Data	Power supply	V-Hz-Ph	220-240-50-1	220-240-50-1
	Sound Pressure Level (H/L)	dB (A)	42/34	42/34
	Air Flow Volume(rated EXP)	CFM	589	589
Fan Motor	Drive Type	-	directly drive	directly drive
	Power Output	W	20	20
	Full Load Amp(FLA)	A	0.5	0.5
	Drainage Connection Size	mm	26	26
Dimension	Outline(W×D×H)	mm	1100×615×200	1100×615×200
	Package(L×W×H)	mm	1323×743×305	1323×743×305
Weight	Net/Gross	kg	31.0/41.0	31.0/41.0
Loading quantity (within panel)		20'GP	72	72
		40'GP	162	162
		40'HQ	162	162

**NOTES:**

- a. The technical parameters are changed along with the products,improvement; please refer to the nameplate of the unit for actual data.
- b. The Heating capacity of the heat pump type is the capacity of heat pump.
- c. Noise is tested in the semi-anechoic room, so it should be slightly higher in the actual operation due to the environ-mental change.
- d. Rated conditions: Cooling : Indoor air temperature 27°C (80.6 °F ) DB/19°C (66.2 °F ) WB,  
 Outdoor air temperature 35°C (95 °F ) DB/24°C (75.2 °F ) WB.  
 Heating : Indoor air temperature 20°C (68 °F ) DB/15°C (59 °F ) WB,  
 Outdoor air temperature 7°C (44.6 °F ) DB/6°C (42.8 °F ) WB.

## ◆ Cassette Type

Model			GKH(12)BA-K3DNA1A/I	GKH(18)BA-K3DNA1A/I	GKH(24)BA-K3DNA1A/I	
Electrical Data	Power supply	V-Hz-Ph	220-240-50-1	220-240-50-1	220-240-50-1	
	Power input	Cooling	kW	0.07	0.07	0.10
		Heating	kW	0.07	0.07	0.10
Sound Pressure Level (H/L)		dB (A)	37/33	37/33	39/35	
Air Flow Volume(rated EXP)		CFM	400	400	694	
Fan Motor	Drive Type	-	directly drive	directly drive	directly drive	
	Power Output	W	35	35	35	
	Full Load Amp(FLA)	A	0.32	0.32	0.43	
Drainage Connection Size		mm	31	31	31	
Dimension	Outline(W×D×H)	mm	840×840×190	840×840×190	840×840×240	
	Package(L×W×H)	mm	963×963×273	963×963×273	963×963×325	
Weight	Net/Gross	kg	25.0/33.0	25.0/33.0	28.0/35.0	
Loading quantity (within panel)		20'GP	48	48	40	
		40'GP	128	128	108	
		40'HQ	144	144	128	
Panel	Outline(W×D×H)	mm	950×950×60	950×950×60	950×950×60	
	Package(W×D×H)	mm	1043×1028×130	1043×1028×130	1043×1028×130	
	Net/Gross Weight	kg	6.5/10	6.5/10	6.5/10	

### NOTES:

- The technical parameters are changed along with the products,improvement; please refer to the nameplate of the unit for actual data.
- The Heating capacity of the heat pump type is the capacity of heat pump.
- Noise is tested in the semi-anechoic room, so it should be slightly higher in the actual operation due to the environ-mental change.
- Rated conditions: Cooling : Indoor air temperature 27°C (80.6 °F ) DB/19°C (66.2 °F ) WB,  
Outdoor air temperature 35°C (95 °F ) DB/24°C (75.2 °F ) WB.  
Heating : Indoor air temperature 20°C (68 °F ) DB/15°C (59 °F ) WB,  
Outdoor air temperature 7°C (44.6 °F ) DB/6°C (42.8 °F ) WB.

Model			GKH(12)BA-K3DNA2A/I	GKH(18)BA-K3DNA2A/I	
Electrical Data	Power supply		V-Hz-Ph	220-240-50-1	220-240-50-1
	Power input	Cooling	kW	0.05	0.05
		Heating	kW	0.05	0.05
Sound Pressure Level (H/L)			dB (A)	46/42	46/42
Air Flow Volume(rated EXP)			CFM	353	353
Fan Motor	Drive Type		-	directly drive	directly drive
	Power Output		W	11	11
	Full Load Amp(FLA)		A	0.2	0.2
Drainage Connection Size			mm	31	31
Dimension	Outline(W×D×H)		mm	570×570×230	570×570×230
	Package(L×W×H)		mm	851×731×325	851×731×325
Weight	Net/Gross		kg	18.0/23.0	18.0/23.0
Loading quantity (within panel)			20'GP	102	102
			40'GP	209	209
			40'HQ	246	246
Panel	Outline(W×D×H)		mm	650×650×50	650×650×50
	Package(W×D×H)		mm	733×673×117	733×673×117
	Net/Gross Weight		kg	2.5/3.5	2.5/3.5

**NOTES:**

- a. The technical parameters are changed along with the products,improvement; please refer to the nameplate of the unit for actual data.
- b. The Heating capacity of the heat pump type is the capacity of heat pump.
- c. Noise is tested in the semi-anechoic room, so it should be slightly higher in the actual operation due to the environ-mental change.
- d. Rated conditions: Cooling : Indoor air temperature 27°C (80.6 °F ) DB/19°C (66.2 °F ) WB,  
Outdoor air temperature 35°C (95 °F ) DB/24°C (75.2 °F ) WB.  
Heating : Indoor air temperature 20°C (68 °F ) DB/15°C (59 °F ) WB,  
Outdoor air temperature 7°C (44.6 °F ) DB/6°C (42.8 °F ) WB.

## ◆ Floor Ceiling Type

Model			GTH(09)BA-K3DNA1A/I	GTH(12)BA-K3DNA1A/I	
Electrical Data	Power supply		V-Hz-Ph	220-240-50-1	220-240-50-1
	Power input	Cooling	kW	0.055	0.055
		Heating	kW	0.055	0.055
Sound Pressure Level (H/L)			dB (A)	40/36	40/36
Air Flow Volume(rated EXP)			CFM	383	383
Fan Motor	Drive Type		-	directly drive	directly drive
	Power Output		W	15	15
	Full Load Amp(FLA)		A	0.3	0.3
Drainage Connection Size			mm	17	17
Dimension	Outline(W×D×H)		mm	1220×700×225	1220×700×225
	Package(L×W×H)		mm	1343×823×315	1343×823×315
Weight	Net/Gross		kg	40.0/50.0	40.0/50.0
Loading quantity (within panel)			20'GP	66	66
			40'GP	132	132
			40'HQ	132	132

### NOTES:

- The technical parameters are changed along with the products,improvement; please refer to the nameplate of the unit for actual data.
- The Heating capacity of the heat pump type is the capacity of heat pump.
- Noise is tested in the semi-anechoic room, so it should be slightly higher in the actual operation due to the environ-mental change.
- Rated conditions: Cooling : Indoor air temperature 27°C (80.6 °F ) DB/19°C (66.2 °F ) WB,  
Outdoor air temperature 35°C (95 °F ) DB/24°C (75.2 °F ) WB.  
Heating : Indoor air temperature 20°C (68 °F ) DB/15°C (59 °F ) WB,  
Outdoor air temperature 7°C (44.6 °F ) DB/6°C (42.8 °F ) WB.

Model			GTH(18)BA-K3DNA1A/I	GTH(24)BA-K3DNA1A/I	
Electrical Data	Power supply		V-Hz-Ph	220-240-50-1	220-240-50-1
	Power input	Cooling	kW	0.11	0.11
		Heating	kW	0.11	0.11
Sound Pressure Level (H/L)			dB (A)	45/40	48/44
Air Flow Volume(rated EXP)			CFM	559	736
Fan Motor	Drive Type		-	directly drive	directly drive
	Power Output		W	20	50
	Full Load Amp(FLA)		A	0.5	0.5
Drainage Connection Size			mm	17	17
Dimension	Outline(W×D×H)		mm	1220×700×225	1220×700×225
	Package(L×W×H)		mm	1343×823×315	1343×823×315
Weight	Net/Gross		kg	40.0/50.0	45.0/54.0
Loading quantity (within panel)			20'GP	66	66
			40'GP	132	132
			40'HQ	132	132

**NOTES:**

- a. The technical parameters are changed along with the products,improvement; please refer to the nameplate of the unit for actual data.
- b. The Heating capacity of the heat pump type is the capacity of heat pump.
- c. Noise is tested in the semi-anechoic room, so it should be slightly higher in the actual operation due to the environ-mental change.
- d. Rated conditions: Cooling : Indoor air temperature 27°C (80.6 °F ) DB/19°C (66.2 °F ) WB,  
Outdoor air temperature 35°C (95 °F ) DB/24°C (75.2 °F ) WB.  
Heating : Indoor air temperature 20°C (68 °F ) DB/15°C (59 °F ) WB,  
Outdoor air temperature 7°C (44.6 °F ) DB/6°C (42.8 °F ) WB.

## 8.2 Outdoor Unit

Outdoor Unit		Model		GWHD(18)NK3FO	GWHD(24)NK3FO
Total Capacity	Cooling	kW		5.00	7.00
		Btu/h		17100	23900
	Heating	kW		5.60	7.70
		Btu/h		19100	26300
EER / C.O.P			W/W	/	/
Electrical Data	Power supply		V-Hz-Ph	220-240-50-1	220-240-50-1
	Power input	Cooling	kW	1.55	2.46
		Heating	kW	1.55	2.56
Sound Pressure Level			dB (A)	56	58
Sound Power Level			dB (A)	63	68
Compressor	Type		—	Inverter Rotary	Inverter Rotary
	Power Input		W	1440	2550
Fan Motor	Model		—	LW60M-ZL	LW92K-ZL
	Drive Type		—	Direct drive	Direct drive
	Power Output		PH	60	90
Dimension	Outline (W×D×H)		mm	955×396×700	980×427×790
	Package (L×W×H)		mm	1029×458×750	1083×488×855
Weight	Net/Gross		kg	50.0/55.0	68.0/73.0
Loading quantity	Outdoor Unit		20'GP	81	44
			40'GP	171	96
			40'HQ	171	144
Connection Pipe	Gas additional charge		g/m	15	15
	Outer Diameter	Liquid Pipe1	Inch	1/4"	1/4"
		Gas Pipe 1	Inch	3/8"	3/8"
		Liquid Pipe2	Inch	1/4"	1/4"
		Gas Pipe 2	Inch	3/8"	3/8"

### NOTES:

- The technical parameters are changed along with the products,improvement; please refer to the nameplate of the unit for actual data
- The Heating capacity of the heat pump type is the capacity of heat pump.
- Noise is tested in the semi-anechoic room, so it should be slightly higher in the actual operation due to the environ-mental change.
- Rated conditions: Cooling : Indoor air temperature 27°C (80.6 °F ) DB/19°C (66.2 °F ) WB,  
Outdoor air temperature 35°C (95 °F ) DB/24°C (75.2 °F ) WB.  
Heating : Indoor air temperature 20°C (68 °F ) DB/15°C (59 °F ) WB,  
Outdoor air temperature 7°C (44.6 °F ) DB/6°C (42.8 °F ) WB.

Outdoor Unit		Model		GWHD(24)NK3GO	GWHD(28)NK3FO
Total Capacity	Cooling	kW		7.10	8.00
		Btu/h		24200	27300
	Heating	kW		8.50	9.30
		Btu/h		29000	31700
EER / C.O.P			W/W	/	/
Electrical Data	Power supply		V-Hz-Ph	220-240-50-1	220-240-50-1
	Power input	Cooling	kW	2.4	2.49
		Heating	kW	2.35	2.58
Sound Pressure Level			dB (A)	58	58
Sound Power Level			dB (A)	68	68
Compressor	Type		—	Inverter Rotary	Inverter Rotary
	Power Input		W	2550	2550
Fan Motor	Model		—	LW92K-ZL	LW92K-ZL
	Drive Type		—	Direct drive	Direct drive
	Power Output		PH	90	90
Dimension	Outline (W×D×H)		mm	980×427×790	980×427×790
	Package (L×W×H)		mm	1083×488×855	1083×488×855
Weight	Net/Gross		kg	69.0/74.0	69.0/74.0
Loading quantity	Outdoor Unit		20'GP	44	44
			40'GP	96	96
			40'HQ	144	144
Connection Pipe	Gas additional charge		g/m	15	15
	Outer Diameter	Liquid Pipe1	Inch	1/4"	1/4"
		Gas Pipe 1	Inch	3/8"	3/8"
		Liquid Pipe2	Inch	1/4"	1/4"
		Gas Pipe 2	Inch	3/8"	3/8"
		Liquid Pipe3	Inch	1/4"	1/4"
		Gas Pipe 3	Inch	3/8"	3/8"
		Liquid Pipe4	Inch	/	1/4"
Gas Pipe 4		Inch	/	3/8"	

**NOTES:**

- a. The technical parameters are changed along with the products,improvement; please refer to the nameplate of the unit for actual data
- b. The Heating capacity of the heat pump type is the capacity of heat pump.
- c. Noise is tested in the semi-anechoic room, so it should be slightly higher in the actual operation due to the environ-mental change.
- d. Rated conditions: Cooling : Indoor air temperature 27°C (80.6 °F ) DB/19°C (66.2 °F ) WB,  
Outdoor air temperature 35°C (95 °F ) DB/24°C (75.2 °F ) WB.  
Heating : Indoor air temperature 20°C (68 °F ) DB/15°C (59 °F ) WB,  
Outdoor air temperature 7°C (44.6 °F ) DB/6°C (42.8 °F )



# FREE MATCH III Multi VRF Technical Sales Guide

Outdoor Unit		Model		GWHD(36)NK3BO	GWHD(42)NK3AO
Total Capacity	Cooling	kW		10.50	12.10
		Btu/h		35826	41285
	Heating	kW		11.00	13.00
		Btu/h		37532	44400
EER / C.O.P			W/W	3.00/3.19	3.37/3.67
Electrical Data	Power supply		V-Hz-Ph	220-240-50-1	220-240-50-1
	Power input	Cooling	kW	3.50	3.59
		Heating	kW	3.45	3.54
Sound Pressure Level			dB (A)	60	54
Sound Power Level			dB (A)	70	64
Compressor	Type		—	Inverter Rotary	Inverter Rotary
	Power Input		W	3300	3010
Fan Motor	Model		—	SWZ150B	LW140B
	Drive Type		—	direct drive	direct drive
	Power Output		PH	170	140
Dimension	Outline (W×D×H)		mm	1015×440×1103	1015×440×1103
	Package (L×W×H)		mm	1158×493×1235	1158×493×1235
Weight	Net/Gross		kg	94.0/104.0	102.0/112.0
Loading quantity	Outdoor Unit		20'GP	22	22
			40'GP	48	48
			40'HQ	96	96
Connection Pipe	Gas additional charge		g/m	22	22
	Outer Diameter	Liquid Pipe1	Inch	1/4	1/4
		Gas Pipe 1	Inch	3/8	3/8
		Liquid Pipe2	Inch	1/4	1/4
		Gas Pipe 2	Inch	3/8	3/8
		Liquid Pipe3	Inch	1/4	1/4
		Gas Pipe 3	Inch	1/2	1/2
		Liquid Pipe4	Inch	3/8	1/4
		Gas Pipe 4	Inch	5/8	1/2
		Liquid Pipe5	Inch		3/8
Gas Pipe 5		Inch		5/8	

## NOTES:

- The technical parameters are changed along with the products,improvement; please refer to the nameplate of the unit for actual data
- The Heating capacity of the heat pump type is the capacity of heat pump.
- Noise is tested in the semi-anechoic room, so it should be slightly higher in the actual operation due to the environ-mental change.
- Rated conditions: Cooling : Indoor air temperature 27°C (80.6 °F ) DB/19°C (66.2 °F ) WB,  
Outdoor air temperature 35°C (95 °F ) DB/24°C (75.2 °F ) WB.  
Heating : Indoor air temperature 20°C (68 °F ) DB/15°C (59 °F ) WB,  
Outdoor air temperature 7°C (44.6 °F ) DB/6°C (42.8 °F ) WB.

## ➔ 8.3 Performance Parameters

### ◆ GWHD(18)NK3FO

GWHD(18)NK3FO (1 to 2) Cooling Performance Parameters							
Indoor units match	Total capacity	Room A	Room B	Room C	Room D	Capacity Rating (Min. ~ Max.)	Power Rating (Min. ~ Max.)
7	7	2100	-	-	-	2100(1500~3500)	850(500~1800)
9	9	2600	-	-	-	2600(1500~3500)	850(500~2000)
12	12	3500	-	-	-	3500(2000~4400)	1100(500~2000)
7+7	14	2050	2050	-	-	4100(2050~4700)	1150(500~2000)
7+9	16	2300	2500	-	-	4800(2050~5800)	1500(500~2550)
9+9	18	2500	2500	-	-	5000(2050~6200)	1550(500~2550)
7+12	19	2000	3500	-	-	5500(2150~6300)	1850(500~2550)
9+12	21	2500	3500	-	-	5800(2150~6300)	2000(500~2550)

GWHD(18)NK3FO (1 to 2) Heating Performance Parameters							
Indoor units match	Total capacity	Room A	Room B	Room C	Room D	Capacity Rating (Min. ~ Max.)	Power Rating (Min. ~ Max.)
7	7	2600	-	-	-	2600(1600~4500)	950(550~2000)
9	9	2800	-	-	-	2800(1600~4500)	1100(550~2000)
12	12	3800	-	-	-	3800(1800~4800)	1150(550~2000)
7+7	14	2250	2250	-	-	4500(2500~6000)	1180(580~2000)
7+9	16	2200	2850	-	-	5050(2500~6650)	1400(580~2500)
9+9	18	2800	2800	-	-	5600(2500~6650)	1540(580~2500)
7+12	19	2250	3800	-	-	6050(2650~6750)	1750(600~2600)
9+12	21	2800	3800	-	-	6300(2650~6750)	1850(600~2600)

### ◆ GWHD(24)NK3FO

GWHD(24)NK3FO (1 to 2) Cooling Performance Parameters							
Indoor units match	Total capacity	Room A	Room B	Room C	Room D	Capacity Rating (Min. ~ Max.)	Power Rating (Min. ~ Max.)
7+7	14	2300	2300	-	-	4600(2000~7800)	1150(600~4200)
7+9	16	2300	2500	-	-	4800(2000~7800)	1420(600~4200)
9+9	18	2500	2500	-	-	5000(2000~7800)	1550(600~4200)
7+12	19	2200	3600	-	-	5800(2100~8000)	1850(650~4300)
9+12	21	2600	3600	-	-	6200(2100~8000)	2000(700~4300)
12+12	24	3500	3500	-	-	7000(2200~8200)	2180(750~4300)
7+18	25	2000	5000	-	-	7000(2200~8200)	2180(800~4400)
9+18	27	2300	4700	-	-	7000(2250~8200)	2180(800~4400)
12+18	30	2800	4200	-	-	7000(2300~8200)	2180(800~4400)

# FREE MATCH III Multi VRF Technical Sales Guide

GWHD(24)NK3FO (1 to 2) Heating Performance Parameters							
Indoor units match	Total capacity	Room A	Room B	Room C	Room D	Capacity Rating (Min. ~ Max.)	Power Rating (Min. ~ Max.)
7+7	14	3000	3000	-	-	6000(3000~8000)	1950(900~3800)
7+9	16	3000	3200	-	-	6200(3000~8500)	2000(900~3850)
9+9	18	3200	3200	-	-	6400(3200~8500)	2050(900~3950)
7+12	19	3000	4000	-	-	7000(3400~9000)	2250(900~4300)
9+12	21	3200	4000	-	-	7200(3500~9300)	2250(900~4400)
12+12	24	3850	3850	-	-	7700(3500~9500)	2260(900~4400)
7+18	25	2200	5500	-	-	7700(3600~9600)	2400(900~4400)
9+18	27	2600	5100	-	-	7700(3700~9900)	2400(900~4400)
12+18	30	3200	4600	-	-	7800(3800~9900)	2400(900~4400)

## ◆ GWHD(24)NK3GO

GWHD(24)NK3GO (2 to 3) Cooling Performance Parameters							
Indoor units match	Total capacity	Room A	Room B	Room C	Room D	Capacity Rating (Min. ~ Max.)	Power Rating (Min. ~ Max.)
7+7	14	2300	2300	-	-	4600(2000~7800)	1150(600~4200)
7+9	16	2300	2500	-	-	4800(2000~7800)	1420(600~4200)
9+9	18	2500	2500	-	-	5000(2000~7800)	1550(600~4200)
7+12	19	2200	3600	-	-	5800(2100~8000)	1850(650~4300)
9+12	21	2600	3600	-	-	6200(2100~8000)	2000(700~4300)
12+12	24	3500	3500	-	-	7000(2200~8200)	2180(750~4300)
7+18	25	2000	5000	-	-	7000(2200~9000)	2180(800~4400)
9+18	27	2300	4700	-	-	7000(2250~9200)	2180(800~4400)
12+18	30	2800	4200	-	-	7000(2300~9500)	2180(800~4400)
18+18	36	3550	3550	-	-	7100(2500~9500)	2200(650~4600)
7+7+7	21	2300	2300	2300	-	6900(2200~9000)	2140(550~4000)
7+7+9	23	2250	2250	2500	-	7000(2200~9200)	2180(550~4200)
7+9+9	25	2200	2450	2450	-	7100(2200~9400)	2200(550~4300)
7+7+12	26	2000	2000	3100	-	7100(2200~9400)	2200(550~4550)
9+9+9	27	2366	2366	2366	-	7100(2200~9500)	2200(650~4600)
7+9+12	28	2000	2150	2950	-	7100(2200~9500)	2200(650~4600)
9+9+12	30	2100	2100	2900	-	7100(2200~9500)	2200(650~4600)
7+12+12	31	1900	2600	2600	-	7100(2200~9600)	2200(650~4650)
9+12+12	33	1900	2600	2600	-	7100(2200~9600)	2200(650~4650)
9+9+18	36	2200	2200	2700	-	7100(2200~9600)	2200(650~4650)
12+12+12	36	2366	2366	2366	-	7100(2200~9600)	2200(650~4650)

GWHD(24)NK3GO (2 to 3) Heating Performance Parameters							
Indoor units match	Total capacity	Room A	Room B	Room C	Room D	Capacity Rating (Min. ~ Max.)	Power Rating (Min. ~ Max.)
7+7	14	3000	3000	-	-	6000(3000~8000)	1950(900~3800)
7+9	16	3000	3200	-	-	6200(3000~8500)	2000(900~3850)
9+9	18	3200	3200	-	-	6400(3200~8500)	2050(900~3950)
7+12	19	3000	4000	-	-	7000(3400~9000)	2250(900~4300)
9+12	21	3200	4000	-	-	7200(3500~9300)	2250(900~4400)
12+12	24	3850	3850	-	-	7700(3500~9500)	2260(900~4400)
7+18	25	2200	5500	-	-	7700(3600~9600)	2400(900~4400)
9+18	27	2600	5100	-	-	7700(3700~9900)	2400(900~4400)
12+18	30	3200	4600	-	-	7800(3800~9900)	2400(900~4400)
18+18	36	3900	3900	-	-	7800(3800~9300)	2400(900~4500)
7+7+7	21	2700	2700	2700	-	8100(3500~9900)	2400(850~4000)
7+7+9	23	2500	2500	3100	-	8100(3500~9900)	2400(850~4000)
7+9+9	25	2400	3050	3050	-	8500(3600~9900)	2400(850~4000)
7+7+12	26	2300	2300	3900	-	8500(3700~9900)	2400(850~4000)
9+9+9	27	2850	2850	2850	-	8500(3700~9900)	2400(850~4000)
7+9+12	28	2100	2750	3650	-	8500(3700~9900)	2400(850~4000)
9+9+12	30	2550	2550	3400	-	8550(3800~9900)	2400(850~4000)
9+12+12	33	2200	3050	3050	-	8550(3800~9900)	2400(850~4000)
9+9+18	36	2220	2220	4100	-	8550(3800~9900)	2400(850~4000)
12+12+12	36	2850	2850	2850	-	8550(3800~9900)	2500(850~4000)

◆ **GWHD(28)NK3FO**

GWHD(28)NK3FO (2 to 4) Cooling Performance Parameters							
Indoor units match	Total capacity	Room A	Room B	Room C	Room D	Capacity Rating (Min. ~ Max.)	Power Rating (Min. ~ Max.)
7+7	14	2300	2300	-	-	4600(2000~7800)	1150(600~4200)
7+9	16	2300	2500	-	-	4800(2000~7800)	1420(600~4200)
9+9	18	2500	2500	-	-	5000(2000~7800)	1550(600~4200)
7+12	19	2200	3600	-	-	5800(2100~8000)	1850(650~4300)
9+12	21	2600	3600	-	-	6200(2100~8000)	2000(700~4300)
12+12	24	3500	3500	-	-	7000(2200~8200)	2180(750~4300)
7+18	25	2000	5000	-	-	7000(2200~9000)	2180(800~4400)
9+18	27	2300	4700	-	-	7000(2250~9200)	2180(800~4400)
12+18	30	2800	4200	-	-	7000(2300~9500)	2180(800~4400)

# FREE MATCH III Multi VRF Technical Sales Guide

18+18	36	3550	3550	-	-	7100(2500~9500)	2200(650~4600)
7+7+7	21	2300	2300	2300	-	6900(2200~9000)	2140(550~4000)
7+7+9	23	2250	2250	2500	-	7000(2200~9200)	2180(550~4200)
7+9+9	25	2200	2450	2450	-	7100(2200~9400)	2200(550~4300)
7+7+12	26	2000	2000	3100	-	7100(2200~9400)	2200(550~4550)
9+9+9	27	2366	2366	2366	-	7100(2200~9500)	2200(650~4600)
7+9+12	28	2000	2150	2950	-	7100(2200~9500)	2200(650~4600)
9+9+12	30	2100	2100	2900	-	7100(2200~9500)	2200(650~4600)
7+12+12	31	1900	2600	2600	-	7100(2200~9600)	2200(650~4650)
9+12+12	33	1900	2600	2600	-	7100(2200~9600)	2200(650~4650)
9+9+18	36	2200	2200	2700	-	7100(2200~9600)	2200(650~4650)
12+12+12	36	2366	2366	2366	-	7100(2200~9600)	2200(650~4650)
7+12+18	37	2100	2300	2700	-	7100(2200~9600)	2200(650~4650)
9+12+18	39	2100	2300	2700	-	7100(2200~9600)	2200(650~4650)
12+12+18	42	2300	2300	2500	-	7100(2200~9600)	2200(650~4650)
7+7+7+7	28	1900	1900	1900	1900	7600(2200~9600)	2360(650~4650)
7+7+7+9	30	1950	1950	1950	2150	8000(2200~9600)	2480(650~4650)
7+7+9+9	32	1900	1900	2100	2100	8000(2200~9600)	2480(650~4650)
7+7+7+12	33	1750	1750	1750	2750	8000(2200~9600)	2480(650~4650)
7+9+9+9	34	1850	2050	2050	2050	8000(2200~9600)	2480(650~4650)
7+7+9+12	35	1700	1700	1850	2750	8000(2200~9600)	2480(650~4650)
9+9+9+9	36	2000	2000	2000	2000	8000(2200~9600)	2480(650~4650)
7+9+9+12	37	2100	2300	2300	2900	8000(2200~11000)	2600(650~3800)
7+7+12+12	38	1700	1700	2300	2300	8000(2200~9600)	2480(650~4650)
7+7+7+18	39	1700	1700	1700	2900	8000(2200~9600)	2480(650~4650)
9+9+9+12	39	1750	1750	1750	2750	8000(2200~9600)	2480(650~4650)
7+9+12+12	40	1400	2000	2300	2300	8000(2200~9600)	2480(650~4650)
7+7+9+18	41	1400	1400	2500	2700	8000(2200~9600)	2480(650~4650)
9+9+12+12	42	1500	1500	2500	2500	8000(2200~10000)	2480(650~4500)
GWHD(28)NK3FO (2 to 4) Heating Performance Parameters							
Indoor units match	Total capacity	Room A	Room B	Room C	Room D	Capacity Rating (Min. ~ Max.)	Power Rating (Min. ~ Max.)
7+7	14	3000	3000	-	-	6000(3000~8000)	1950(900~3800)
7+9	16	3000	3200	-	-	6200(3000~8500)	2000(900~3850)
9+9	18	3200	3200	-	-	6400(3200~8500)	2050(900~3950)
7+12	19	3000	4000	-	-	7000(3400~9000)	2250(900~4300)

9+12	21	3200	4000	-	-	7200(3500~9300)	2250(900~4400)
12+12	24	3850	3850	-	-	7700(3500~9500)	2260(900~4400)
7+18	25	2200	5500	-	-	7700(3600~9600)	2400(900~4400)
9+18	27	2600	5100	-	-	7700(3700~9900)	2400(900~4400)
12+18	30	3200	4600	-	-	7800(3800~9900)	2400(900~4400)
18+18	36	3900	3900	-	-	7800(3800~9300)	2400(900~4500)
7+7+7	21	2700	2700	2700	-	8100(3500~9900)	2400(850~4000)
7+7+9	23	2500	2500	3100	-	8100(3500~9900)	2400(850~4000)
7+9+9	25	2400	3050	3050	-	8500(3600~9900)	2400(850~4000)
7+7+12	26	2300	2300	3900	-	8500(3700~9900)	2400(850~4000)
9+9+9	27	2850	2850	2850	-	8500(3700~9900)	2400(850~4000)
7+9+12	28	2100	2750	3650	-	8500(3700~9900)	2400(850~4000)
9+9+12	30	2550	2550	3400	-	8550(3800~9900)	2400(850~4000)
9+12+12	33	2200	3050	3050	-	8550(3800~9900)	2400(850~4000)
9+9+18	36	2220	2220	4100	-	8550(3800~9900)	2400(850~4000)
12+12+12	36	2850	2850	2850	-	8550(3800~9900)	2500(850~4000)
7+7+7+7	28	2300	2300	2300	2300	9200(3900~11000)	2550(950~4000)
7+7+7+9	30	2250	2250	2250	2550	9300(3900~11000)	2550(950~4000)
7+7+9+9	32	2100	2100	2550	2550	9300(3900~11000)	2550(950~4000)
7+7+7+12	33	2100	2100	2100	3000	9300(3900~11000)	2550(950~4000)
7+9+9+9	34	2100	2400	2400	2400	9300(3900~11000)	2550(950~4000)
7+7+9+12	35	2200	2200	2200	2700	9300(3900~11000)	2550(950~4000)
9+9+9+9	36	2325	2325	2325	2325	9300(3900~11000)	2550(980~4000)
7+9+9+12	37	2100	2300	2300	2900	9600(3900~11000)	2600(900~4000)
7+7+12+12	38	2100	2300	2300	2900	9600(3900~11000)	2600(900~4000)
7+7+7+18	39	2000	2000	2000	3600	9600(3900~11000)	2600(900~4000)
9+9+9+12	39	2200	2200	2200	3000	9600(3900~11000)	2550(980~4000)
7+9+12+12	40	2000	2200	2700	2700	9600(3900~11000)	2600(900~4000)
7+7+9+18	41	2100	2100	2400	3000	9600(3900~11000)	2600(900~4000)
9+9+12+12	42	2100	2100	2700	2700	9600(3900~11000)	2550(980~4000)

◆ **GWHD(36)NK3BO**

GWHD(36)NK3BO (2 to 4) Cooling Performance Parameters							
Indoor units match	Total capacity	Room A	Room B	Room C	Room D	Capacity Rating (Min. ~ Max.)	Power Rating (Min. ~ Max.)
7+12	19	2300	3600	-	-	5800(3000~7800)	1810(1300~4300)
7+18	25	2100	5000	-	-	7100(3000~9000)	2700(1300~4400)

# FREE MATCH III Multi VRF Technical Sales Guide

7+21	28	2000	6000	-	-	8000(3000~9000)	2700(1300~4400)
7+24	31	1900	6100	-	-	8000(3000~9000)	2700(1300~4600)
9+9	18	2500	2500	-	-	5000(3000~7800)	1810(1300~4300)
9+12	21	2500	3600	-	-	6000(3000~8000)	1810(1300~4300)
9+18	27	2200	4900	-	-	7100(3000~9200)	2700(1300~4400)
9+21	30	2000	6000	-	-	8000(3000~9200)	2700(1300~4400)
9+24	33	2000	6000	-	-	8000(3000~9200)	2700(1300~4600)
12+12	24	3000	3000	-	-	6000(3000~9200)	2700(1300~4300)
12+18	30	3100	4000	-	-	8000(3000~9500)	3030(1300~4600)
12+21	33	3000	5000	-	-	8000(3000~9500)	3030(1300~4600)
12+24	36	3000	5000	-	-	8000(3000~9500)	3030(1300~4600)
18+18	36	4000	4000	-	-	8000(3000~9500)	3030(1300~4600)
18+21	39	3600	4500	-	-	8000(3000~9500)	3030(1300~4600)
18+24	42	3600	4500	-	-	8000(3000~9500)	3030(1300~4600)
21+21	42	4000	4000	-	-	8000(3000~9500)	3030(1300~4600)
21+24	45	4000	4000	-	-	8000(3000~9500)	3030(1300~4600)
24+24	48	4000	4000	-	-	8000(3000~9500)	3030(1300~4600)
7+7+7	21	2300	2300	2300	-	6900(3000~9000)	2700(1500~4300)
7+7+9	23	2250	2250	2500	-	7000(3000~9000)	2700(1500~4300)
7+7+12	26	2000	2000	3100	-	7100(3000~9000)	2700(1500~4400)
7+7+18	32	2100	2100	4500	-	8700(3000~9600)	3030(1500~4600)
7+7+21	35	1950	1950	4800	-	8700(3000~9600)	3030(1500~4600)
7+7+24	38	1850	1850	5000	-	8700(3000~9600)	3030(1500~4600)
7+9+9	25	2200	2450	2450	-	7100(3000~9000)	2700(1500~4400)
7+9+12	28	2000	2100	3000	-	7100(3000~9000)	2700(1500~4400)
7+9+18	34	2000	2200	4500	-	8700(3000~9600)	3030(1500~4600)
7+9+21	37	1900	2000	4800	-	8700(3000~9600)	3030(1500~4600)
7+9+24	40	1900	2000	5000	-	8700(3000~9600)	3030(1500~4600)
7+12+12	31	2100	3300	3300	-	8700(3000~9600)	3030(1500~4600)
7+12+18	37	1700	3000	4000	-	8700(3000~9600)	3030(1500~4600)
7+12+21	40	1500	2400	4800	-	8700(3000~9600)	3030(1500~4600)
7+12+24	43	1500	2400	4800	-	8700(3000~9600)	3030(1500~4600)
7+18+18	43	1700	3600	3600	-	8700(3000~9600)	3030(1500~4600)
7+18+21	46	1500	2700	4500	-	8700(3000~9600)	3030(1500~4600)
7+18+24	49	1500	2700	4500	-	8700(3000~9600)	3030(1500~4600)

7+21+21	49	1450	3625	3625	-	8700(3000~9600)	3030(1500~4600)
9+9+9	27	2400	2400	2400	-	7200(3000~9000)	2700(1500~4400)
9+9+12	30	2050	2150	3000	-	7200(3000~9000)	2700(1500~4400)
9+9+18	36	2100	2100	4500	-	8700(3000~9600)	3030(1500~4600)
9+9+21	39	1850	1850	5000	-	8700(3000~9600)	3030(1500~4600)
9+9+24	42	1850	1850	5000	-	8700(3000~9600)	3030(1500~4600)
9+12+12	33	2200	3250	3250	-	8700(3000~9600)	3030(1500~4600)
9+12+18	39	1800	2950	3950	-	8700(3000~9600)	3030(1500~4600)
9+12+21	42	1600	2350	4750	-	8700(3000~9600)	3030(1500~4600)
9+12+24	45	1600	2350	4750	-	8700(3000~9600)	3030(1500~4600)
9+18+18	45	1750	3450	3450	-	8700(3000~9600)	3030(1500~4600)
9+18+21	48	1600	2650	4450	-	8700(3000~9600)	3030(1500~4600)
9+18+24	51	1600	2650	4450	-	8700(3000~9600)	3030(1500~4600)
9+21+21	51	1500	3600	3600	-	8700(3000~9600)	3030(1500~4600)
12+12+12	36	2900	2900	2900	-	8700(3000~9600)	3030(1500~4600)
12+12+18	42	2500	2500	3700	-	8700(3000~9600)	3030(1500~4600)
12+12+21	45	2200	2200	4300	-	8700(3000~9600)	3030(1500~4600)
12+12+24	48	2200	2200	4300	-	8700(3000~9600)	3030(1500~4600)
12+18+18	48	2700	3600	3600	-	8700(3000~9600)	3030(1500~4600)
12+18+21	51	1600	3100	4000	-	8700(3000~9600)	3030(1500~4600)
18+18+18	54	2900	2900	2900	-	8700(3000~9600)	3030(1500~4600)
7+7+7+7	28	2150	2150	2150	2150	8600(3000~9600)	2700(1500~4400)
7+7+7+9	30	2100	2100	2100	2300	8600(3000~9600)	2700(1500~4400)
7+7+7+12	33	2250	2250	2250	3050	9800(3000~10000)	3030(1500~4600)
7+7+7+18	39	1850	1850	1850	4250	9800(3000~10000)	3030(1500~4600)
7+7+7+21	42	1600	1600	1600	5000	9800(3000~10000)	3030(1500~4600)
7+7+7+24	45	1550	1550	1550	5150	9800(3000~10000)	3030(1500~4600)
7+7+9+9	32	2000	2000	2300	2300	8600(3000~9600)	2700(1500~4600)
7+7+9+12	35	2100	2100	2250	3250	9800(3000~10000)	3030(1500~4600)
7+7+9+18	41	1800	1800	2200	4000	9800(3000~10000)	3030(1500~4600)
7+7+9+21	44	1700	1700	2000	4400	9800(3000~10000)	3030(1500~4600)
7+7+9+24	47	1700	1700	2000	4400	9800(3000~10000)	3030(1500~4600)
7+7+12+12	38	2000	2000	2900	2900	9800(3000~10000)	3030(1500~4600)
7+7+12+18	44	1700	1700	2400	4000	9800(3000~10000)	3030(1500~4600)
7+7+12+21	47	1600	1600	2200	4400	9800(3000~10000)	3030(1500~4600)



# FREE MATCH III Multi VRF Technical Sales Guide

7+7+12+24	50	1600	1600	2200	4400	9800(3000~10000)	3030(1500~4600)
7+7+18+18	50	1600	1600	3600	3600	9800(3000~10000)	3030(1500~4600)
7+9+9+9	34	2300	2500	2500	2500	9800(3000~10000)	3030(1500~4600)
7+9+9+12	37	2100	2250	2250	3200	9800(3000~10000)	3030(1500~4600)
7+9+9+18	43	1900	2050	2050	3600	9800(3000~10000)	3030(1500~4600)
7+9+9+21	46	1600	2000	2000	4400	9800(3000~10000)	3030(1500~4600)
7+9+9+24	49	1600	2000	2000	4400	9800(3000~10000)	3030(1500~4600)
7+9+12+12	40	1800	1900	2900	2900	9800(3000~10000)	3030(1500~4600)
7+9+12+18	46	1800	1900	2600	3600	9800(3000~10000)	3030(1500~4600)
7+9+12+21	49	1550	1650	2700	3900	9800(3000~10000)	3030(1500~4600)
7+9+18+18	52	1550	1650	3300	3300	9800(3000~10000)	3030(1500~4600)
7+12+12+12	43	1850	2650	2650	2650	9800(3000~10000)	3030(1500~4600)
7+12+12+18	46	1500	2300	2300	3700	9800(3000~10000)	3030(1500~4600)
9+9+9+9	36	2450	2450	2450	2450	9800(3000~10000)	3030(1500~4600)
9+9+9+12	39	2200	2200	2200	3200	9800(3000~10000)	3030(1500~4600)
9+9+9+18	45	2000	2000	2000	3600	9800(3000~10000)	3030(1500~4600)
9+9+9+21	48	1800	1800	1800	4400	9800(3000~10000)	3030(1500~4600)
9+9+9+24	51	1800	1800	1800	4400	9800(3000~10000)	3030(1500~4600)
9+9+12+12	42	2000	2000	2900	2900	9800(3000~10000)	3030(1500~4600)
9+9+12+18	48	1850	1850	2600	3600	9800(3000~10000)	3030(1500~4600)
9+9+12+21	51	1600	1600	2700	3900	9800(3000~10000)	3030(1500~4600)
9+9+18+18	54	1600	1600	3300	3300	9800(3000~10000)	3030(1500~4600)
9+12+12+12	45	2300	2500	2500	2500	9800(3000~10000)	3030(1500~4600)
9+12+12+18	51	1800	2200	2200	3600	9800(3000~10000)	3030(1500~4600)
12+12+12+12	48	2450	2450	2450	2450	9800(3000~10000)	3030(1500~4600)

## GWHD(36)NK3BO (2 to 4) Heating Performance Parameters

Indoor units match	Total capacity	Room A	Room B	Room C	Room D	Capacity Rating (Min. ~ Max.)	Power Rating (Min. ~ Max.)
7+12	19	2990	4680	-	-	7540(4500~9000)	1798(1300~3870)
7+18	25	2730	6500	-	-	9230(4500~9600)	2682(1300~3960)
7+21	28	2400	7200	-	-	9600(4500~9900)	2682(1300~3960)
7+24	31	2280	7320	-	-	9600(4500~9900)	2682(1300~4140)
9+9	18	3250	3250	-	-	6500(4500~8500)	1798(1300~3870)
9+12	21	3250	4680	-	-	7800(4500~9600)	2100(1300~3870)
9+18	27	2860	6370	-	-	9230(4500~9900)	2682(1300~3960)
9+21	30	2400	7200	-	-	9600(4500~9900)	2682(1300~3960)

9+24	33	2400	7200	-	-	9600(4500~9900)	2682(1300~4140)
12+12	24	3900	3900	-	-	7800(4500~9900)	2682(1300~3870)
12+18	30	3720	4800	-	-	9600(4500~9900)	3010(1300~4140)
12+21	33	3600	6000	-	-	9600(4500~9900)	3010(1300~4140)
12+24	36	3600	6000	-	-	9600(4500~9900)	3010(1300~4140)
18+18	36	4800	4800	-	-	9600(4500~9900)	3010(1300~4140)
18+21	39	4320	5400	-	-	9600(4500~9900)	3010(1300~4140)
18+24	42	4320	5400	-	-	9600(4500~9900)	3010(1300~4140)
21+21	42	4800	4800	-	-	9600(4500~9900)	3010(1300~4140)
21+24	45	4800	4800	-	-	9600(4500~9900)	3010(1300~4140)
24+24	48	4800	4800	-	-	9600(4500~9900)	3010(1300~4140)
7+7+7	21	2530	2530	2530	-	7590(4500~9900)	2682(1500~3870)
7+7+9	23	2475	2475	2750	-	7700(4500~9900)	2682(1500~3870)
7+7+12	26	2200	2200	3410	-	7810(4500~9900)	2682(1500~3960)
7+7+18	32	2520	2520	5400	-	10440(4500~11000)	3010(1500~4140)
7+7+21	35	2340	2340	5760	-	10440(4500~11000)	3010(1500~4140)
7+7+24	38	2220	2220	6000	-	10440(4500~11000)	3010(1500~4140)
7+9+9	25	2420	2695	2695	-	7810(4500~9900)	2682(1500~3960)
7+9+12	28	2200	2310	3300	-	7810(4500~9900)	2682(1500~3960)
7+9+18	34	2400	2640	5400	-	10440(4500~11000)	3010(1500~4140)
7+9+21	37	2280	2400	5760	-	10440(4500~11000)	3010(1500~4140)
7+9+24	40	2280	2400	6000	-	10440(4500~11000)	3010(1500~4140)
7+12+12	31	2520	3960	3960	-	10440(4500~11000)	3010(1500~4140)
7+12+18	37	2040	3600	4800	-	10440(4500~11000)	3010(1500~4140)
7+12+21	40	1800	2880	5760	-	10440(4500~11000)	3010(1500~4140)
7+12+24	43	1800	2880	5760	-	10440(4500~11000)	3010(1500~4140)
7+18+18	43	2040	4320	4320	-	10440(4500~11000)	3010(1500~4140)
7+18+21	46	1800	3240	5400	-	10440(4500~11000)	3010(1500~4140)
7+18+24	49	1800	3240	5400	-	10440(4500~11000)	3010(1500~4140)
7+21+21	49	1740	4350	4350	-	10440(4500~11000)	3010(1500~4140)
9+9+9	27	2640	2640	2640	-	7920(4500~9900)	2682(1500~3960)
9+9+12	30	2255	2365	3300	-	7920(4500~9900)	2682(1500~3960)
9+9+18	36	2520	2520	5400	-	10440(4500~11000)	3010(1500~4140)
9+9+21	39	2220	2220	6000	-	10440(4500~11000)	3010(1500~4140)
9+9+24	42	2220	2220	6000	-	10440(4500~11000)	3010(1500~4140)

# FREE MATCH III Multi VRF Technical Sales Guide

9+12+12	33	2640	3900	3900	-	10440(4500~11000)	3010(1500~4140)
9+12+18	39	2160	3540	4740	-	10440(4500~11000)	3010(1500~4140)
9+12+21	42	1920	2820	5700	-	10440(4500~11000)	3010(1500~4140)
9+12+24	45	1920	2820	5700	-	10440(4500~11000)	3010(1500~4140)
9+18+18	45	2100	4140	4140	-	10440(4500~11000)	3010(1500~4140)
9+18+21	48	1920	3180	5340	-	10440(4500~11000)	3010(1500~4140)
9+18+24	51	1920	3180	5340	-	10440(4500~11000)	3010(1500~4140)
9+21+21	51	1800	4320	4320	-	10440(4500~11000)	3010(1500~4140)
12+12+12	36	3480	3480	3480	-	10440(4500~11000)	3010(1500~4140)
12+12+18	42	3000	3000	4440	-	10440(4500~11000)	3010(1500~4140)
12+12+21	45	2640	2640	5160	-	10440(4500~11000)	3010(1500~4140)
12+12+24	48	2640	2640	5160	-	10440(4500~11000)	3010(1500~4140)
12+18+18	48	3240	4320	4320	-	10440(4500~11000)	3010(1500~4140)
12+18+21	51	1920	3720	4800	-	10440(4500~11000)	3010(1500~4140)
18+18+18	54	3480	3480	3480	-	10440(4500~11000)	3010(1500~4140)
7+7+7+7	28	2365	2365	2365	2365	9460(4500~11000)	2682(1500~3960)
7+7+7+9	30	2310	2310	2310	2530	9460(4500~11000)	2682(1500~3960)
7+7+7+12	33	2700	2700	2700	3660	11760(4500~12000)	3010(1500~4140)
7+7+7+18	39	2220	2220	2220	5100	11760(4500~12000)	3010(1500~4140)
7+7+7+21	42	1920	1920	1920	6000	11760(4500~12000)	3010(1500~4140)
7+7+7+24	45	1860	1860	1860	6180	11760(4500~12000)	3010(1500~4140)
7+7+9+9	32	2200	2200	2530	2530	9460(4500~11000)	2682(1500~4140)
7+7+9+12	35	2520	2520	2700	3900	11760(4500~12000)	3010(1500~4140)
7+7+9+18	41	2160	2160	2640	4800	11760(4500~12000)	3010(1500~4140)
7+7+9+21	44	2040	2040	2400	5280	11760(4500~12000)	3010(1500~4140)
7+7+9+24	47	2040	2040	2400	5280	11760(4500~12000)	3010(1500~4140)
7+7+12+12	38	2400	2400	3480	3480	11760(4500~12000)	3010(1500~4140)
7+7+12+18	44	2040	2040	2880	4800	11760(4500~12000)	3010(1500~4140)
7+7+12+21	47	1920	1920	2640	5280	11760(4500~12000)	3010(1500~4140)
7+7+12+24	50	1920	1920	2640	5280	11760(4500~12000)	3010(1500~4140)
7+7+18+18	50	1920	1920	4320	4320	11760(4500~12000)	3010(1500~4140)
7+9+9+9	34	2760	3000	3000	3000	11760(4500~12000)	3010(1500~4140)
7+9+9+12	37	2520	2700	2700	3840	11760(4500~12000)	3010(1500~4140)
7+9+9+18	43	2280	2460	2460	4320	11760(4500~12000)	3010(1500~4140)
7+9+9+21	46	1920	2400	2400	5280	11760(4500~12000)	3010(1500~4140)

7+9+9+24	49	1920	2400	2400	5280	11760(4500~12000)	3010(1500~4140)
7+9+12+12	40	2160	2280	3480	3480	11760(4500~12000)	3010(1500~4140)
7+9+12+18	46	2160	2280	3120	4320	11760(4500~12000)	3010(1500~4140)
7+9+12+21	49	1860	1980	3240	4680	11760(4500~12000)	3010(1500~4140)
7+9+18+18	52	1860	1980	3960	3960	11760(4500~12000)	3010(1500~4140)
7+12+12+12	43	2220	3180	3180	3180	11760(4500~12000)	3010(1500~4140)
7+12+12+18	46	1800	2760	2760	4440	11760(4500~12000)	3010(1500~4140)
9+9+9+9	36	2940	2940	2940	2940	11760(4500~12000)	3010(1500~4140)
9+9+9+12	39	2640	2640	2640	3840	11760(4500~12000)	3010(1500~4140)
9+9+9+18	45	2400	2400	2400	4320	11760(4500~12000)	3010(1500~4140)
9+9+9+21	48	2160	2160	2160	5280	11760(4500~12000)	3010(1500~4140)
9+9+9+24	51	2160	2160	2160	5280	11760(4500~12000)	3010(1500~4140)
9+9+12+12	42	2400	2400	3480	3480	11760(4500~12000)	3010(1500~4140)
9+9+12+18	48	2220	2220	3120	4320	11760(4500~12000)	3010(1500~4140)
9+9+12+21	51	1920	1920	3240	4680	11760(4500~12000)	3010(1500~4140)
9+9+18+18	54	1920	1920	3960	3960	11760(4500~12000)	3010(1500~4140)
9+12+12+12	45	2760	3000	3000	3000	11760(4500~12000)	3010(1500~4140)
9+12+12+18	51	2160	2640	2640	4320	11760(4500~12000)	3010(1500~4140)
12+12+12+12	48	2940	2940	2940	2940	11760(4500~12000)	3010(1500~4140)

◆ **GWHD(42)NK3AO**

GWHD(42)NK3AO (2 to 5) Cooling Performance Parameters								
Indoor units match	Total capacity	Room A	Room B	Room C	Room D	Room E	Capacity Rating (Min. ~ Max.)	Power Rating (Min. ~ Max.)
7+18	25	2100	5000	-	-	-	7100(3500~9000)	2198(1800~4900)
7+21	28	2000	6000	-	-	-	8000(3500~9000)	2450(1800~4900)
7+24	31	1900	6100	-	-	-	8000(3500~9000)	2450(1800~4900)
9+12	21	2500	3500	-	-	-	6000(3500~9000)	1858(1300~4700)
9+18	27	2200	4900	-	-	-	7100(3500~9000)	2150(1800~4900)
9+21	30	2000	6000	-	-	-	8000(3500~9000)	2450(1800~4900)
9+24	33	2000	6000	-	-	-	8000(3500~9000)	2450(1800~4900)
12+12	24	3000	3000	-	-	-	6000(3500~8000)	1858(1300~4900)
12+18	30	3100	4900	-	-	-	8000(3500~9000)	2450(1800~4900)
12+21	33	3500	6000	-	-	-	9500(3500~11000)	2940(2000~4900)
12+24	36	3000	6500	-	-	-	9500(3500~11000)	2940(2000~4900)
18+18	36	4750	4750	-	-	-	9500(3500~11000)	2940(2000~4900)
18+21	39	4300	5200	-	-	-	9500(3500~11000)	2940(2000~4900)

# FREE MATCH III Multi VRF Technical Sales Guide

18+24	42	4100	5500	-	-	-	9500(3500~11000)	2940(2000~4900)
21+21	42	4750	4750	-	-	-	9500(3500~11000)	2940(2000~4900)
21+24	45	4700	4800	-	-	-	9500(3500~11000)	2940(2000~4900)
24+24	48	4750	4750	-	-	-	9500(3500~11000)	2940(2000~4900)
7+7+7	21	2300	2300	2300	-	-	6900(3500~9000)	2130(1800~4900)
7+7+9	23	2250	2250	2500	-	-	7000(3500~9000)	2130(1800~4900)
7+7+12	26	2000	2000	3100	-	-	7100(3500~9000)	2150(1800~4900)
7+7+18	32	2100	2100	4500	-	-	8700(3500~9600)	2650(1800~4900)
7+7+21	35	2000	2000	5500	-	-	9500(3500~11000)	2940(2000~4900)
7+7+24	38	1850	1850	5800	-	-	9500(3500~11000)	2940(2000~4900)
7+9+9	25	2200	2450	2450	-	-	7100(3500~9000)	2150(1800~4900)
7+9+12	28	2000	2100	3000	-	-	7100(3500~9000)	2150(1800~4900)
7+9+18	34	2250	2400	4850	-	-	9500(3500~11000)	2940(2000~4900)
7+9+21	37	2100	2200	5200	-	-	9500(3500~11000)	2940(2000~4900)
7+9+24	40	2050	2150	5300	-	-	9500(3500~11000)	2940(2000~4900)
7+12+12	31	2100	3300	3300	-	-	8700(3500~9600)	2650(2000~4900)
7+12+18	37	2200	3100	5100	-	-	10400(3500~12200)	3200(2000~4900)
7+12+21	40	2100	3000	5300	-	-	10400(3500~12200)	3200(2000~4900)
7+12+24	43	2050	2950	5400	-	-	10400(3500~12200)	3200(2000~4900)
7+18+18	43	1900	4250	4250	-	-	10400(3500~12200)	3200(2000~4900)
7+18+21	46	1900	4200	5500	-	-	11600(3500~13600)	3590(2000~4900)
7+18+24	49	1900	4100	5600	-	-	11600(3500~13600)	3590(2000~4900)
7+21+21	49	1800	4900	4900	-	-	11600(3500~13600)	3590(2000~4900)
7+21+24	52	1700	4900	5000	-	-	11600(3500~13600)	3590(2000~4900)
7+24+24	55	1600	5000	5000	-	-	11600(3500~13600)	3590(2000~4900)
9+9+9	27	2400	2400	2400	-	-	7200(3500~9000)	2150(1800~4900)
9+9+12	30	2050	2150	3000	-	-	7200(3500~9000)	2150(1800~4900)
9+9+18	36	2350	2350	4800	-	-	9500(3500~11000)	2940(2000~4900)
9+9+21	39	2450	2450	5500	-	-	10400(3500~12200)	3200(2000~4900)
9+9+24	42	2400	2400	5600	-	-	10400(3500~12200)	3200(2000~4900)
9+12+12	33	2500	3100	3100	-	-	8700(3500~9600)	2650(1800~4900)
9+12+18	39	2500	3200	4700	-	-	10400(3500~12200)	3200(2000~4900)
9+12+21	42	2300	2800	5300	-	-	10400(3500~12200)	3200(2000~4900)
9+12+24	45	2300	2800	6500	-	-	11600(3500~13600)	3590(2000~4900)
9+18+18	45	2100	4400	4400	-	-	11600(3500~13600)	3590(2000~4900)

9+18+21	48	2000	4100	5500	-	-	11600(3500~13600)	3590(2000~4900)
9+18+24	51	2000	4000	5600	-	-	11600(3500~13600)	3590(2000~4900)
9+21+21	51	1800	4900	4900	-	-	11600(3500~13600)	3590(2000~4900)
9+21+24	54	1750	4900	4950	-	-	11600(3500~13600)	3590(2000~4900)
9+24+24	57	1700	4950	4950	-	-	11600(3500~13600)	3590(2000~4900)
12+12+12	36	3450	3450	3500	-	-	10400(3500~12200)	3200(2000~4900)
12+12+18	42	3200	3200	4000	-	-	10400(3500~12200)	3200(2000~4900)
12+12+21	45	3000	3000	5600	-	-	11600(3500~13600)	3590(2000~4900)
12+12+24	48	2950	2950	5700	-	-	11600(3500~13600)	3590(2000~4900)
12+18+18	48	2800	4400	4400	-	-	11600(3500~13600)	3590(2000~4900)
12+18+21	51	2700	4200	4700	-	-	11600(3500~13600)	3590(2000~4900)
12+18+24	54	2650	4150	4800	-	-	11600(3500~13600)	3590(2000~4900)
12+21+21	54	2600	4500	4500	-	-	11600(3500~13600)	3590(2000~4900)
12+21+24	57	2550	4450	4600	-	-	11600(3500~13600)	3590(2000~4900)
12+24+24	60	2500	4550	4550	-	-	11600(3500~13600)	3590(2000~4900)
18+18+18	54	3850	3850	3900	-	-	11600(3500~13600)	3590(2000~4900)
18+18+21	57	3650	3650	4300	-	-	11600(3500~13600)	3590(2000~4900)
18+18+24	60	3600	3600	4400	-	-	11600(3500~13600)	3590(2000~4900)
18+21+21	60	3600	4000	4000	-	-	11600(3500~13600)	3590(2000~4900)
21+21+21	63	3850	3850	3900	-	-	11600(3500~13600)	3590(2000~4900)
7+7+7+7	28	2150	2150	2150	2150	-	8600(3500~9600)	2650(1800~4900)
7+7+7+9	30	2100	2100	2100	2300	-	8600(3500~9600)	2650(1800~4900)
7+7+7+12	33	2100	2100	2100	3200	-	9500(3500~11000)	2940(2000~4900)
7+7+7+18	39	2000	2000	2000	4400	-	10400(3500~12200)	3200(2000~4900)
7+7+7+21	42	1800	1800	1800	5000	-	10400(3500~12200)	3200(2000~4900)
7+7+7+24	45	2000	2000	2000	5600	-	11600(3500~13600)	3590(2000~4900)
7+7+9+9	32	2000	2000	2300	2300	-	8600(3500~9600)	2650(2000~4900)
7+7+9+12	35	2000	2000	2300	3200	-	9500(3500~11000)	2650(2000~4900)
7+7+9+18	41	1900	1900	2300	4300	-	10400(3500~12200)	3200(2000~4900)
7+7+9+21	44	1950	1950	2200	5500	-	11600(3500~13600)	3590(2000~4900)
7+7+9+24	47	1900	1900	2200	5600	-	11600(3500~13600)	3590(2000~4900)
7+7+12+12	38	2000	2000	3200	3200	-	10400(3500~12200)	3200(2000~4900)
7+7+12+18	44	2000	2000	3100	4500	-	11600(3500~13600)	3590(2000~4900)
7+7+12+21	47	1800	1800	2900	5100	-	11600(3500~13600)	3590(2000~4900)
7+7+12+24	50	1800	1800	2800	5200	-	11600(3500~13600)	3590(2000~4900)

# FREE MATCH III Multi VRF Technical Sales Guide

7+7+18+18	50	1900	1900	3900	3900	-	11600(3500~13600)	3590(2000~4900)
7+7+18+21	43	1800	1800	3500	4500	-	11600(3500~13600)	3590(2000~4900)
7+7+18+24	46	1750	1750	3100	5000	-	11600(3500~13600)	3590(2000~4900)
7+7+21+21	56	1600	1600	4200	4200	-	11600(3500~13600)	3590(2000~4900)
7+7+21+24	59	1550	1550	4250	4250	-	11600(3500~13600)	3590(2000~4900)
7+9+9+9	34	2300	2400	2400	2400	-	9500(3500~11000)	2940(2000~4900)
7+9+9+12	37	2000	2200	2200	3100	-	9500(3500~11000)	2940(2000~4900)
7+9+9+18	43	2200	2300	2300	4800	-	11600(3500~13600)	3590(2000~4900)
7+9+9+21	46	1900	2100	2100	5500	-	11600(3500~13600)	3590(2000~4900)
7+9+9+24	49	1800	2100	2100	5600	-	11600(3500~13600)	3590(2000~4900)
7+9+12+12	40	2000	2200	2200	3100	-	9500(3500~11000)	2940(2000~4900)
7+9+12+18	46	1900	2100	3100	4500	-	11600(3500~13600)	3590(2000~4900)
7+9+12+21	49	1750	1850	2900	5100	-	11600(3500~13600)	3590(2000~4900)
7+9+12+24	52	1800	1850	2800	5150	-	11600(3500~13600)	3590(2000~4900)
7+9+18+18	52	1850	1950	3900	3900	-	11600(3500~13600)	3590(2000~4900)
7+9+18+21	55	1850	1900	3450	4400	-	11600(3500~13600)	3590(2000~4900)
7+9+18+24	58	1750	1800	3050	5000	-	11600(3500~13600)	3590(2000~4900)
7+9+21+21	58	1600	1800	4100	4100	-	11600(3500~13600)	3590(2000~4900)
7+9+21+24	61	1550	1650	4200	4200	-	11600(3500~13600)	3590(2000~4900)
7+12+12+12	43	2000	2000	3200	3200	-	10400(3500~12200)	3200(2000~4900)
7+12+12+18	46	1900	2600	2600	4500	-	11600(3500~13600)	3590(2000~4900)
7+12+12+21	52	1700	2400	2400	5100	-	11600(3500~13600)	3590(2000~4900)
7+12+12+24	55	1800	2325	2325	5150	-	11600(3500~13600)	3590(2000~4900)
7+12+18+18	55	1800	2400	3700	3700	-	11600(3500~13600)	3590(2000~4900)
7+12+18+21	58	1850	2000	3450	4300	-	11600(3500~13600)	3590(2000~4900)
7+12+18+24	61	1750	2000	3050	4800	-	11600(3500~13600)	3590(2000~4900)
7+12+21+21	61	1600	2000	4000	4000	-	11600(3500~13600)	3590(2000~4900)
7+18+18+18	61	1700	3300	3300	3300	-	11600(3500~13600)	3590(2000~4900)
9+9+9+9	36	2600	2600	2600	2600	-	10400(3500~12200)	3200(2000~4900)
9+9+9+12	39	2400	2400	2400	3200	-	10400(3500~12200)	3200(2000~4900)
9+9+9+18	45	2300	2300	2300	4700	-	11600(3500~13600)	3590(2000~4900)
9+9+9+21	48	2050	2050	2050	5450	-	11600(3500~13600)	3590(2000~4900)
9+9+9+24	51	2000	2000	2000	5600	-	11600(3500~13600)	3590(2000~4900)
9+9+12+12	42	2100	2100	3100	3100	-	10400(3500~12200)	3200(2000~4900)
9+9+12+18	48	2000	2000	3100	4500	-	11600(3500~13600)	3590(2000~4900)

9+9+12+21	51	1800	1800	2900	5100	-	11600(3500~13600)	3590(2000~4900)
9+9+12+24	54	1850	1850	2800	5150	-	11600(3500~13600)	3590(2000~4900)
9+9+18+18	54	1900	1900	3900	3900	-	11600(3500~13600)	3590(2000~4900)
9+9+18+21	57	1900	1900	3450	4350	-	11600(3500~13600)	3590(2000~4900)
9+9+18+24	60	1800	1800	3050	4950	-	11600(3500~13600)	3590(2000~4900)
9+9+21+21	60	1700	1700	4100	4100	-	11600(3500~13600)	3590(2000~4900)
9+12+12+12	45	2300	3100	3100	3100	-	11600(3500~13600)	3590(2000~4900)
9+12+12+18	51	2100	2550	2550	4400	-	11600(3500~13600)	3590(2000~4900)
9+12+12+21	54	1900	2350	2350	5000	-	11600(3500~13600)	3590(2000~4900)
9+12+12+24	57	1900	2325	2325	5050	-	11600(3500~13600)	3590(2000~4900)
9+12+18+18	57	1900	2400	3650	3650	-	11600(3500~13600)	3590(2000~4900)
9+12+18+21	58	1900	2000	3450	4250	-	11600(3500~13600)	3590(2000~4900)
9+12+21+21	62	1800	2000	3900	3900	-	11600(3500~13600)	3590(2000~4900)
9+18+18+18	63	1700	3300	3300	3300	-	11600(3500~13600)	3590(2000~4900)
12+12+12+12	48	2900	2900	2900	2900	-	11600(3500~13600)	3590(2000~4900)
12+12+12+18	54	2450	2450	2450	4250	-	11600(3500~13600)	3590(2000~4900)
12+12+12+21	57	2200	2200	2200	5000	-	11600(3500~13600)	3590(2000~4900)
12+12+12+24	60	2200	2200	2200	5000	-	11600(3500~13600)	3590(2000~4900)
12+12+18+18	60	2300	2300	3500	3500	-	11600(3500~13600)	3590(2000~4900)
12+12+18+21	63	2000	2000	3400	4200	-	11600(3500~13600)	3590(2000~4900)
7+7+7+7+7	35	2080	2080	2080	2080	2080	10400(3500~12200)	3200(2000~4900)
7+7+7+7+9	37	2050	2050	2050	2050	2200	10400(3500~12200)	3200(2000~4900)
7+7+7+7+12	40	1950	1950	1950	1950	2600	10400(3500~12200)	3200(2000~4900)
7+7+7+7+18	46	1950	1950	1950	1950	3800	11600(3500~13600)	3590(2000~4900)
7+7+7+7+21	49	1850	1850	1850	1850	4200	11600(3500~13600)	3590(2000~4900)
7+7+7+7+24	52	1850	1850	1850	1850	4200	11600(3500~13600)	3590(2000~4900)
7+7+7+9+9	39	2000	2000	2000	2200	2200	10400(3500~12200)	3200(2000~4900)
7+7+7+9+12	42	2100	2100	2100	2300	3000	11600(3500~13600)	3590(2000~4900)
7+7+7+9+18	48	1950	1950	1950	2050	3700	11600(3500~13600)	3590(2000~4900)
7+7+7+9+21	51	1850	1850	1850	1950	4100	11600(3500~13600)	3590(2000~4900)
7+7+7+9+24	54	1850	1850	1850	1950	4100	11600(3500~13600)	3590(2000~4900)
7+7+7+12+12	45	2000	2000	2000	2800	2800	11600(3500~13600)	3590(2000~4900)
7+7+7+12+18	51	1850	1850	1850	2500	3550	11600(3500~13600)	3590(2000~4900)
7+7+7+12+21	54	1800	1800	1800	2400	3800	11600(3500~13600)	3590(2000~4900)
7+7+7+12+24	57	1800	1800	1800	2400	3800	11600(3500~13600)	3590(2000~4900)



# FREE MATCH III Multi VRF Technical Sales Guide

7+7+7+18+18	57	1800	1800	1800	3100	3100	11600(3500~13600)	3590(2000~4900)
7+7+7+18+21	60	1700	1700	1700	2800	3700	11600(3500~13600)	3590(2000~4900)
7+7+9+9+9	41	1900	1900	2200	2200	2200	10400(3500~12200)	3200(2000~4900)
7+7+9+9+12	44	2100	2100	2200	2200	3000	11600(3500~13600)	3590(2000~4900)
7+7+9+9+18	50	1950	1950	2000	2000	3700	11600(3500~13600)	3590(2000~4900)
7+7+9+9+21	53	1850	1850	1900	1900	4100	11600(3500~13600)	3590(2000~4900)
7+7+9+9+24	56	1850	1850	1900	1900	4100	11600(3500~13600)	3590(2000~4900)
7+7+9+12+12	47	2000	2000	2100	2750	2750	11600(3500~13600)	3590(2000~4900)
7+7+9+12+18	53	1850	1850	1900	2500	3500	11600(3500~13600)	3590(2000~4900)
7+7+9+12+21	56	1800	1800	1900	2350	3750	11600(3500~13600)	3590(2000~4900)
7+7+9+12+24	59	1800	1800	1900	2350	3750	11600(3500~13600)	3590(2000~4900)
7+7+9+18+18	49	1800	1800	1900	3050	3050	11600(3500~13600)	3590(2000~4900)
7+7+9+18+21	52	1700	1700	1800	2750	3650	11600(3500~13600)	3590(2000~4900)
7+7+12+12+12	50	1900	1900	2600	2600	2600	11600(3500~13600)	3590(2000~4900)
7+7+12+12+18	56	1700	1700	2400	2400	3400	11600(3500~13600)	3590(2000~4900)
7+7+12+12+21	59	1700	1700	2200	2200	3800	11600(3500~13600)	3590(2000~4900)
7+7+12+18+18	62	1800	1800	2200	2900	2900	11600(3500~13600)	3590(2000~4900)
7+9+9+9+9	43	2200	2350	2350	2350	2350	11600(3500~13600)	3590(2000~4900)
7+9+9+9+12	46	2050	2200	2200	2200	2950	11600(3500~13600)	3590(2000~4900)
7+9+9+9+18	52	1900	2000	2000	2000	3700	11600(3500~13600)	3590(2000~4900)
7+9+9+9+21	55	1850	1900	1900	1900	4050	11600(3500~13600)	3590(2000~4900)
7+9+9+9+24	58	1850	1900	1900	1900	4050	11600(3500~13600)	3590(2000~4900)
7+9+9+12+12	49	2000	2100	2100	2700	2700	11600(3500~13600)	3590(2000~4900)
7+9+9+12+18	55	1850	1900	1900	2450	3500	11600(3500~13600)	3590(2000~4900)
7+9+9+12+21	58	1800	1900	1900	2300	3700	11600(3500~13600)	3590(2000~4900)
7+9+9+12+24	61	1800	1900	1900	2300	3700	11600(3500~13600)	3590(2000~4900)
7+9+9+18+18	61	1800	1900	1900	3000	3000	11600(3500~13600)	3590(2000~4900)
7+9+12+12+12	42	1850	1950	2600	2600	2600	11600(3500~13600)	3590(2000~4900)
7+9+12+12+18	48	1700	1800	2350	2350	3400	11600(3500~13600)	3590(2000~4900)
7+9+12+12+21	51	1700	1800	2200	2200	3700	11600(3500~13600)	3590(2000~4900)
7+12+12+12+12	55	1800	2450	2450	2450	2450	11600(3500~13600)	3590(2000~4900)
7+12+12+12+18	61	1650	2250	2250	2250	3200	11600(3500~13600)	3590(2000~4900)
9+9+9+9+9	45	2320	2320	2320	2320	2320	11600(3500~13600)	3590(2000~4900)
9+9+9+9+12	48	2175	2175	2175	2175	2900	11600(3500~13600)	3590(2000~4900)
9+9+9+9+18	54	2000	2000	2000	2000	3600	11600(3500~13600)	3590(2000~4900)

9+9+9+9+21	57	1900	1900	1900	1900	4000	11600(3500~13600)	3590(2000~4900)
9+9+9+9+24	60	1900	1900	1900	1900	4000	11600(3500~13600)	3590(2000~4900)
9+9+9+12+12	51	2100	2100	2100	2650	2650	11600(3500~13600)	3590(2000~4900)
9+9+9+12+18	57	1900	1900	1900	2425	3475	11600(3500~13600)	3590(2000~4900)
9+9+9+12+21	60	1900	1900	1900	2250	3650	11600(3500~13600)	3590(2000~4900)
9+9+9+18+18	63	1900	1900	1900	2950	2950	11600(3500~13600)	3590(2000~4900)
9+9+12+12+12	54	1900	1900	2600	2600	2600	11600(3500~13600)	3590(2000~4900)
9+9+12+12+18	60	1750	1750	2350	2350	3400	11600(3500~13600)	3590(2000~4900)
9+9+12+12+21	63	1750	1750	2200	2200	3700	11600(3500~13600)	3590(2000~4900)
9+12+12+12+12	57	1900	2425	2425	2425	2425	11600(3500~13600)	3590(2000~4900)
9+12+12+12+18	63	1800	2225	2225	2225	3125	11600(3500~13600)	3590(2000~4900)
12+12+12+12+12	60	2320	2320	2320	2320	2320	11600(3500~13600)	3590(2000~4900)
GWHD(42)NK3AO (2 to 5) Heating Performance Parameters								
Indoor units match	Total capacity	Room A	Room B	Room C	Room D	Room E	Capacity Rating (Min. ~ Max.)	Power Rating (Min. ~ Max.)
7+18	25	2625	6250	-	-	-	8875(4500~9900)	2171(1800~4400)
7+21	28	2500	7500	-	-	-	10000(4500~11000)	2419(1800~4400)
7+24	31	2375	7625	-	-	-	10000(4500~11000)	2419(1800~4400)
9+12	21	3125	4375	-	-	-	7500(4500~9900)	1834(1300~4200)
9+18	27	2750	6125	-	-	-	8875(4500~9900)	2123(1800~4400)
9+21	30	2500	7500	-	-	-	10000(4500~11000)	2419(1800~4400)
9+24	33	2500	7500	-	-	-	10000(4500~11000)	2419(1800~4400)
12+12	24	3750	3750	-	-	-	7500(4500~8800)	1834(1300~4400)
12+18	30	3875	6125	-	-	-	10000(4500~11000)	2419(1800~4400)
12+21	33	4375	7500	-	-	-	11875(4500~12500)	2903(2000~4400)
12+24	36	3750	8125	-	-	-	11875(4500~12500)	2903(2000~4400)
18+18	36	5938	5938	-	-	-	11875(4500~12500)	2903(2000~4400)
18+21	39	5375	6500	-	-	-	11875(4500~12500)	2903(2000~4400)
18+24	42	5125	6875	-	-	-	11875(4500~12500)	2903(2000~4400)
21+21	42	5938	5938	-	-	-	11875(4500~12500)	2903(2000~4400)
21+24	45	5875	6000	-	-	-	11875(4500~12500)	2903(2000~4400)
24+24	48	5938	5938	-	-	-	11875(4500~12500)	2903(2000~4400)
7+7+7	21	2875	2875	2875	-	-	8625(4500~12000)	2103(1800~4400)
7+7+9	23	2813	2813	3125	-	-	8750(4500~12000)	2103(1800~4400)
7+7+12	26	2500	2500	3875	-	-	8875(4500~12000)	2123(1800~4400)
7+7+18	32	2625	2625	5625	-	-	10875(4500~12000)	2617(1800~4400)

# FREE MATCH III Multi VRF Technical Sales Guide

7+7+21	35	2500	2500	6875	-	-	11875(4500~12500)	2903(2000~4400)
7+7+24	38	2313	2313	7250	-	-	11875(4500~12500)	2903(2000~4400)
7+9+9	25	2750	3063	3063	-	-	8875(4500~12000)	2123(1800~4400)
7+9+12	28	2500	2625	3750	-	-	8875(4500~12000)	2123(1800~4400)
7+9+18	34	2813	3000	6063	-	-	11875(4500~12500)	2903(2000~4400)
7+9+21	37	2625	2750	6500	-	-	11875(4500~12500)	2903(2000~4400)
7+9+24	40	2563	2688	6625	-	-	11875(4500~12500)	2903(2000~4400)
7+12+12	31	2625	4125	4125	-	-	10875(4500~12000)	2617(2000~4400)
7+12+18	37	2750	3875	6375	-	-	13000(4500~13200)	3160(2000~4400)
7+12+21	40	2625	3750	6625	-	-	13000(4500~13200)	3160(2000~4400)
7+12+24	43	2563	3688	6750	-	-	13000(4500~13200)	3160(2000~4400)
7+18+18	43	2375	5313	5313	-	-	13000(4500~13200)	3160(2000~4400)
7+18+21	46	2162	4779	6259	-	-	13200(4500~14000)	3545(2000~4400)
7+18+24	49	2162	4666	6372	-	-	13200(4500~14000)	3545(2000~4400)
7+21+21	49	2048	5576	5576	-	-	13200(4500~14000)	3545(2000~4400)
7+21+24	52	1934	5576	5690	-	-	13200(4500~14000)	3545(2000~4400)
7+24+24	55	1821	5690	5690	-	-	13200(4500~14000)	3545(2000~4400)
9+9+9	27	3000	3000	3000	-	-	9000(4500~12000)	2123(1800~4400)
9+9+12	30	2563	2688	3750	-	-	9000(4500~12000)	2123(1800~4400)
9+9+18	36	2938	2938	6000	-	-	11875(4500~12500)	2903(2000~4400)
9+9+21	39	3063	3063	6875	-	-	13000(4500~13200)	3160(2000~4400)
9+9+24	42	3000	3000	7000	-	-	13000(4500~13200)	3160(2000~4400)
9+12+12	33	3125	3875	3875	-	-	10875(4500~12000)	2617(1800~4400)
9+12+18	39	3125	4000	5875	-	-	13000(4500~13200)	3160(2000~4400)
9+12+21	42	2875	3500	6625	-	-	13000(4500~13200)	3160(2000~4400)
9+12+24	45	2617	3186	7397	-	-	13200(4500~14000)	3545(2000~4400)
9+18+18	45	2390	5007	5007	-	-	13200(4500~14000)	3545(2000~4400)
9+18+21	48	2276	4666	6259	-	-	13200(4500~14000)	3545(2000~4400)
9+18+24	51	2276	4552	6372	-	-	13200(4500~14000)	3545(2000~4400)
9+21+21	51	2048	5576	5576	-	-	13200(4500~14000)	3545(2000~4400)
9+21+24	54	1991	5576	5633	-	-	13200(4500~14000)	3545(2000~4400)
9+24+24	57	1934	5633	5633	-	-	13200(4500~14000)	3545(2000~4400)
12+12+12	36	4313	4313	4375	-	-	13000(4500~13200)	3160(2000~4400)
12+12+18	42	4000	4000	5000	-	-	13000(4500~13200)	3160(2000~4400)
12+12+21	45	3414	3414	6372	-	-	13200(4500~14000)	3545(2000~4400)

12+12+24	48	3357	3357	6486	-	-	13200(4500~14000)	3545(2000~4400)
12+18+18	48	3186	5007	5007	-	-	13200(4500~14000)	3545(2000~4400)
12+18+21	51	3072	4779	5348	-	-	13200(4500~14000)	3545(2000~4400)
12+18+24	54	3016	4722	5462	-	-	13200(4500~14000)	3545(2000~4400)
12+21+21	54	2959	5121	5121	-	-	13200(4500~14000)	3545(2000~4400)
12+21+24	57	2902	5064	5234	-	-	13200(4500~14000)	3545(2000~4400)
12+24+24	60	2845	5178	5178	-	-	13200(4500~14000)	3545(2000~4400)
18+18+18	54	4381	4381	4438	-	-	13200(4500~14000)	3545(2000~4400)
18+18+21	57	4153	4153	4893	-	-	13200(4500~14000)	3545(2000~4400)
18+18+24	60	4097	4097	5007	-	-	13200(4500~14000)	3545(2000~4400)
18+21+21	60	4097	4552	4552	-	-	13200(4500~14000)	3545(2000~4400)
21+21+21	63	4381	4381	4438	-	-	13200(4500~14000)	3545(2000~4400)
7+7+7+7	28	2688	2688	2688	2688	-	10750(4500~12000)	2617(1800~4400)
7+7+7+9	30	2625	2625	2625	2875	-	10750(4500~12000)	2617(1800~4400)
7+7+7+12	33	2625	2625	2625	4000	-	11875(4500~12500)	2903(2000~4400)
7+7+7+18	39	2500	2500	2500	5500	-	13000(4500~14000)	3160(2000~4400)
7+7+7+21	42	2250	2250	2250	6250	-	13000(4500~14000)	3160(2000~4400)
7+7+7+24	45	2276	2276	2276	6372	-	13200(4500~14000)	3545(2000~4400)
7+7+9+9	32	2500	2500	2875	2875	-	10750(4500~14000)	2617(2000~4400)
7+7+9+12	35	2500	2500	2875	4000	-	11875(4500~14000)	2617(2000~4400)
7+7+9+18	41	2375	2375	2875	5375	-	13000(4500~14000)	3160(2000~4400)
7+7+9+21	44	2219	2219	2503	6259	-	13199.99(4500~14000)	3545(2000~4400)
7+7+9+24	47	2162	2162	2503	6372	-	13199.99(4500~14000)	3545(2000~4400)
7+7+12+12	38	2500	2500	4000	4000	-	13000(4500~14000)	3160(2000~4400)
7+7+12+18	44	2500	2500	3875	5121	-	13200(4500~14000)	3545(2000~4400)
7+7+12+21	47	2250	2250	3625	5803	-	13200(4500~14000)	3545(2000~4400)
7+7+12+24	50	2250	2250	3500	5917	-	13200(4500~14000)	3545(2000~4400)
7+7+18+18	50	2375	2375	4875	4438	-	13200(4500~14000)	3545(2000~4400)
7+7+18+21	43	2250	2250	4375	5121	-	13200(4500~14000)	3545(2000~4400)
7+7+18+24	46	2188	2188	3875	5690	-	13200(4500~14000)	3545(2000~4400)
7+7+21+21	56	2000	2000	5250	4779	-	13200(4500~14000)	3545(2000~4400)
7+7+21+24	59	1938	1938	5313	4836	-	13200(4500~14000)	3545(2000~4400)
7+9+9+9	34	2875	3000	3000	3000	-	11875(4500~14000)	2903(2000~4400)
7+9+9+12	37	2500	2750	2750	3875	-	11875(4500~14000)	2903(2000~4400)
7+9+9+18	43	2503	2617	2617	5462	-	13200(4500~14000)	3545(2000~4400)
7+9+9+21	46	2162	2390	2390	6259	-	13200(4500~14000)	3545(2000~4400)

# FREE MATCH III Multi VRF Technical Sales Guide

7+9+9+24	49	2048	2390	2390	6372	-	13200(4500~14000)	3545(2000~4400)
7+9+12+12	40	2500	2750	2750	3875	-	11875(4500~14000)	2903(2000~4400)
7+9+12+18	46	2162	2390	3528	5121	-	13200(4500~14000)	3545(2000~4400)
7+9+12+21	49	1991	2105	3300	5803	-	13200(4500~14000)	3545(2000~4400)
7+9+12+24	52	2048	2105	3186	5860	-	13200(4500~14000)	3545(2000~4400)
7+9+18+18	52	2105	2219	4438	4438	-	13200(4500~14000)	3545(2000~4400)
7+9+18+21	55	2105	2162	3926	5007	-	13200(4500~14000)	3545(2000~4400)
7+9+18+24	58	1991	2048	3471	5690	-	13200(4500~14000)	3545(2000~4400)
7+9+21+21	58	1821	2048	4666	4666	-	13200(4500~14000)	3545(2000~4400)
7+9+21+24	61	1764	1878	4779	4779	-	13200(4500~14000)	3545(2000~4400)
7+12+12+12	43	2500	2500	4000	4000	-	13000(4500~14000)	3160(2000~4400)
7+12+12+18	46	2162	2959	2959	5121	-	13200(4500~14000)	3545(2000~4400)
7+12+12+21	52	1934	2731	2731	5803	-	13200(4500~14000)	3545(2000~4400)
7+12+12+24	55	2048	2646	2646	5860	-	13200(4500~14000)	3545(2000~4400)
7+12+18+18	55	2048	2731	4210	4210	-	13200(4500~14000)	3545(2000~4400)
7+12+18+21	58	2105	2276	3926	4893	-	13200(4500~14000)	3545(2000~4400)
7+12+18+24	61	1991	2276	3471	5462	-	13200(4500~14000)	3545(2000~4400)
7+12+21+21	61	1821	2276	4552	4552	-	13200(4500~14000)	3545(2000~4400)
7+18+18+18	61	1934	3755	3755	3755	-	13200(4500~14000)	3545(2000~4400)
9+9+9+9	36	3250	3250	3250	3250	-	13000(4500~14000)	3160(2000~4400)
9+9+9+12	39	3000	3000	3000	4000	-	13000(4500~14000)	3160(2000~4400)
9+9+9+18	45	2617	2617	2617	5348	-	13200(4500~14000)	3545(2000~4400)
9+9+9+21	48	2333	2333	2333	6202	-	13200(4500~14000)	3545(2000~4400)
9+9+9+24	51	2276	2276	2276	6372	-	13200(4500~14000)	3545(2000~4400)
9+9+12+12	42	2625	2625	3875	3875	-	13000(4500~14000)	3160(2000~4400)
9+9+12+18	48	2276	2276	3528	5121	-	13200(4500~14000)	3545(2000~4400)
9+9+12+21	51	2048	2048	3300	5803	-	13200(4500~14000)	3545(2000~4400)
9+9+12+24	54	2105	2105	3186	5860	-	13200(4500~14000)	3545(2000~4400)
9+9+18+18	54	2162	2162	4438	4438	-	13200(4500~14000)	3545(2000~4400)
9+9+18+21	57	2162	2162	3926	4950	-	13200(4500~14000)	3545(2000~4400)
9+9+18+24	60	2048	2048	3471	5633	-	13200(4500~14000)	3545(2000~4400)
9+9+21+21	60	1934	1934	4666	4666	-	13200(4500~14000)	3545(2000~4400)
9+12+12+12	45	2617	3528	3528	3528	-	13200(4500~14000)	3545(2000~4400)
9+12+12+18	51	2390	2902	2902	5007	-	13200(4500~14000)	3545(2000~4400)
9+12+12+21	54	2162	2674	2674	5690	-	13200(4500~14000)	3545(2000~4400)
9+12+12+24	57	2162	2646	2646	5747	-	13200(4500~14000)	3545(2000~4400)

9+12+18+18	57	2162	2731	4153	4153	-	13200(4500~14000)	3545(2000~4400)
9+12+18+21	58	2162	2276	3926	4836	-	13200(4500~14000)	3545(2000~4400)
9+12+21+21	62	2048	2276	4438	4438	-	13200(4500~14000)	3545(2000~4400)
9+18+18+18	63	1934	3755	3755	3755	-	13200(4500~14000)	3545(2000~4400)
12+12+12+12	48	3300	3300	3300	3300	-	13200(4500~14000)	3545(2000~4400)
12+12+12+18	54	2788	2788	2788	4836	-	13200(4500~14000)	3545(2000~4400)
12+12+12+21	57	2503	2503	2503	5690	-	13200(4500~14000)	3545(2000~4400)
12+12+12+24	60	2503	2503	2503	5690	-	13200(4500~14000)	3545(2000~4400)
12+12+18+18	60	2617	2617	3983	3983	-	13200(4500~14000)	3545(2000~4400)
12+12+18+21	63	2276	2276	3869	4779	-	13200(4500~14000)	3545(2000~4400)
7+7+7+7+7	35	2600	2600	2600	2600	2600	13000(4500~14000)	3160(2000~4400)
7+7+7+7+9	37	2563	2563	2563	2563	2750	13000(4500~14000)	3160(2000~4400)
7+7+7+7+12	40	2438	2438	2438	2438	3250	13000(4500~14000)	3160(2000~4400)
7+7+7+7+18	46	2219	2219	2219	2219	4324	13200(4500~14000)	3545(2000~4400)
7+7+7+7+21	49	2105	2105	2105	2105	4779	13200(4500~14000)	3545(2000~4400)
7+7+7+7+24	52	2105	2105	2105	2105	4779	13200(4500~14000)	3545(2000~4400)
7+7+7+9+9	39	2500	2500	2500	2750	2750	13000(4500~14000)	3160(2000~4400)
7+7+7+9+12	42	2390	2390	2390	2617	3414	13200(4500~14000)	3545(2000~4400)
7+7+7+9+18	48	2219	2219	2219	2333	4210	13200(4500~14000)	3545(2000~4400)
7+7+7+9+21	51	2105	2105	2105	2219	4666	13200(4500~14000)	3545(2000~4400)
7+7+7+9+24	54	2105	2105	2105	2219	4666	13200(4500~14000)	3545(2000~4400)
7+7+7+12+12	45	2276	2276	2276	3186	3186	13200(4500~14000)	3545(2000~4400)
7+7+7+12+18	51	2105	2105	2105	2845	4040	13200(4500~14000)	3545(2000~4400)
7+7+7+12+21	54	2048	2048	2048	2731	4324	13200(4500~14000)	3545(2000~4400)
7+7+7+12+24	57	2048	2048	2048	2731	4324	13200(4500~14000)	3545(2000~4400)
7+7+7+18+18	57	2048	2048	2048	3528	3528	13200(4500~14000)	3545(2000~4400)
7+7+7+18+21	60	1934	1934	1934	3186	4210	13200(4500~14000)	3545(2000~4400)
7+7+9+9+9	41	2375	2375	2750	2750	2750	13000(4500~14000)	3160(2000~4400)
7+7+9+9+12	44	2390	2390	2503	2503	3414	13200(4500~14000)	3545(2000~4400)
7+7+9+9+18	50	2219	2219	2276	2276	4210	13200(4500~14000)	3545(2000~4400)
7+7+9+9+21	53	2105	2105	2162	2162	4666	13200(4500~14000)	3545(2000~4400)
7+7+9+9+24	56	2105	2105	2162	2162	4666	13200(4500~14000)	3545(2000~4400)
7+7+9+12+12	47	2276	2276	2390	3129	3129	13200(4500~14000)	3545(2000~4400)
7+7+9+12+18	53	2105	2105	2162	2845	3983	13200(4500~14000)	3545(2000~4400)
7+7+9+12+21	56	2048	2048	2162	2674	4267	13200(4500~14000)	3545(2000~4400)
7+7+9+12+24	59	2048	2048	2162	2674	4267	13200(4500~14000)	3545(2000~4400)

# FREE MATCH III Multi VRF Technical Sales Guide

7+7+9+18+18	49	2048	2048	2162	3471	3471	13200(4500~14000)	3545(2000~4400)
7+7+9+18+21	52	1934	1934	2048	3129	4153	13200(4500~14000)	3545(2000~4400)
7+7+12+12+12	50	2162	2162	2959	2959	2959	13200(4500~14000)	3545(2000~4400)
7+7+12+12+18	56	1934	1934	2731	2731	3869	13200(4500~14000)	3545(2000~4400)
7+7+12+12+21	59	1934	1934	2503	2503	4324	13200(4500~14000)	3545(2000~4400)
7+7+12+18+18	62	2048	2048	2503	3300	3300	13200(4500~14000)	3545(2000~4400)
7+9+9+9+9	43	2503	2674	2674	2674	2674	13200(4500~14000)	3545(2000~4400)
7+9+9+9+12	46	2333	2503	2503	2503	3357	13200(4500~14000)	3545(2000~4400)
7+9+9+9+18	52	2162	2276	2276	2276	4210	13200(4500~14000)	3545(2000~4400)
7+9+9+9+21	55	2105	2162	2162	2162	4609	13200(4500~14000)	3545(2000~4400)
7+9+9+9+24	58	2105	2162	2162	2162	4609	13200(4500~14000)	3545(2000~4400)
7+9+9+12+12	49	2276	2390	2390	3072	3072	13200(4500~14000)	3545(2000~4400)
7+9+9+12+18	55	2105	2162	2162	2788	3983	13200(4500~14000)	3545(2000~4400)
7+9+9+12+21	58	2048	2162	2162	2617	4210	13200(4500~14000)	3545(2000~4400)
7+9+9+12+24	61	2048	2162	2162	2617	4210	13200(4500~14000)	3545(2000~4400)
7+9+9+18+18	61	2048	2162	2162	3414	3414	13200(4500~14000)	3545(2000~4400)
7+9+12+12+12	42	2105	2219	2959	2959	2959	13200(4500~14000)	3545(2000~4400)
7+9+12+12+18	48	1934	2048	2674	2674	3869	13200(4500~14000)	3545(2000~4400)
7+9+12+12+21	51	1934	2048	2503	2503	4210	13200(4500~14000)	3545(2000~4400)
7+12+12+12+12	55	2048	2788	2788	2788	2788	13200(4500~14000)	3545(2000~4400)
7+12+12+12+18	61	1878	2560	2560	2560	3641	13200(4500~14000)	3545(2000~4400)
9+9+9+9+9	45	2640	2640	2640	2640	2640	13200(4500~14000)	3545(2000~4400)
9+9+9+9+12	48	2475	2475	2475	2475	3300	13200(4500~14000)	3545(2000~4400)
9+9+9+9+18	54	2276	2276	2276	2276	4097	13200(4500~14000)	3545(2000~4400)
9+9+9+9+21	57	2162	2162	2162	2162	4552	13200(4500~14000)	3545(2000~4400)
9+9+9+9+24	60	2162	2162	2162	2162	4552	13200(4500~14000)	3545(2000~4400)
9+9+9+12+12	51	2390	2390	2390	3016	3016	13200(4500~14000)	3545(2000~4400)
9+9+9+12+18	57	2162	2162	2162	2759	3954	13200(4500~14000)	3545(2000~4400)
9+9+9+12+21	60	2162	2162	2162	2560	4153	13200(4500~14000)	3545(2000~4400)
9+9+9+18+18	63	2162	2162	2162	3357	3357	13200(4500~14000)	3545(2000~4400)
9+9+12+12+12	54	2162	2162	2959	2959	2959	13200(4500~14000)	3545(2000~4400)
9+9+12+12+18	60	1991	1991	2674	2674	3869	13200(4500~14000)	3545(2000~4400)
9+9+12+12+21	63	1991	1991	2503	2503	4210	13200(4500~14000)	3545(2000~4400)
9+12+12+12+12	57	2162	2759	2759	2759	2759	13200(4500~14000)	3545(2000~4400)
9+12+12+12+18	63	2048	2532	2532	2532	3556	13200(4500~14000)	3545(2000~4400)
12+12+12+12+12	60	2640	2640	2640	2640	2640	13200(4500~14000)	3545(2000~4400)

# 9 FAN CHARACTERISTICS

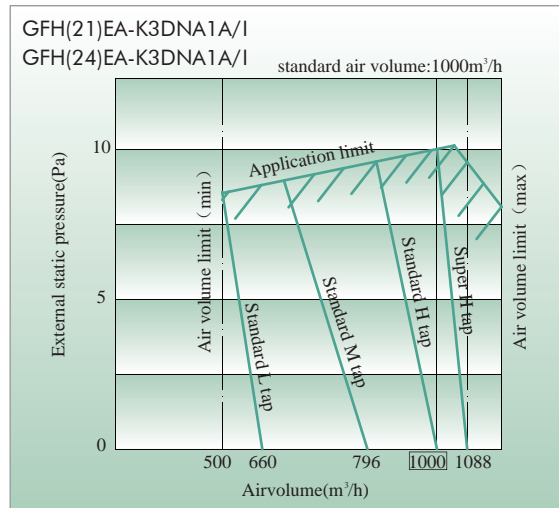
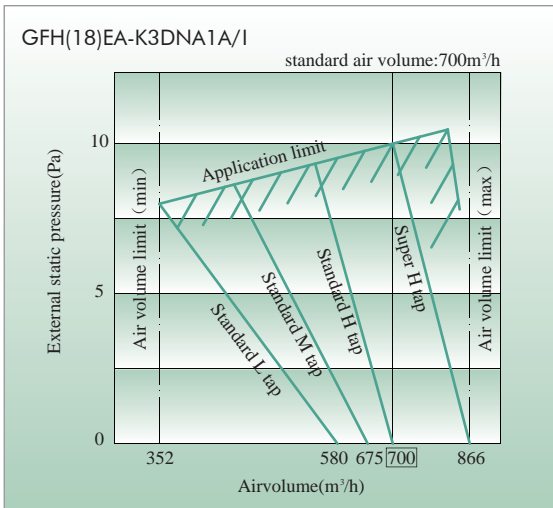
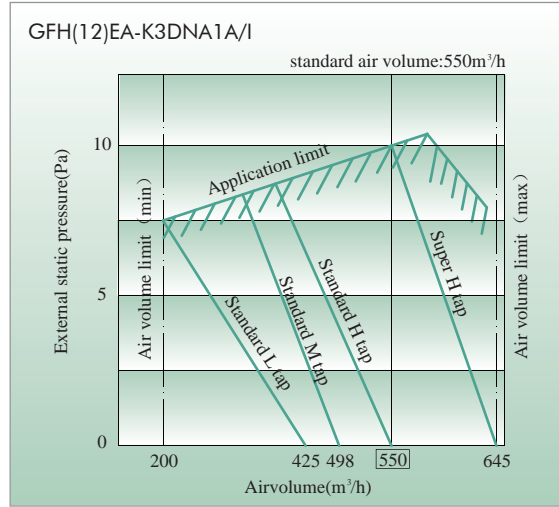
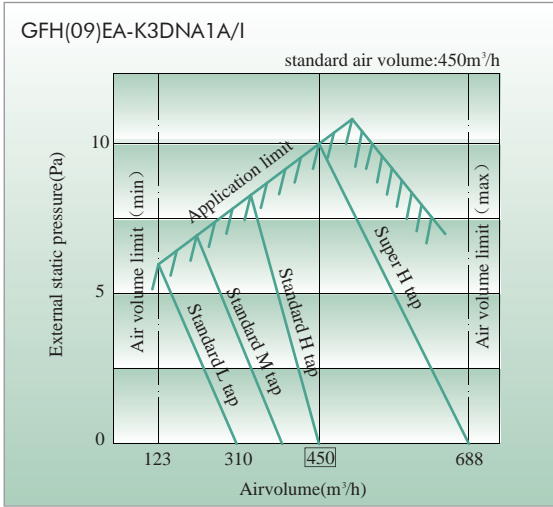



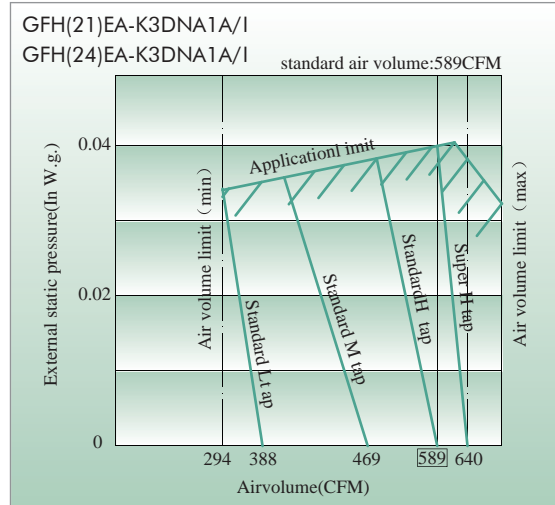
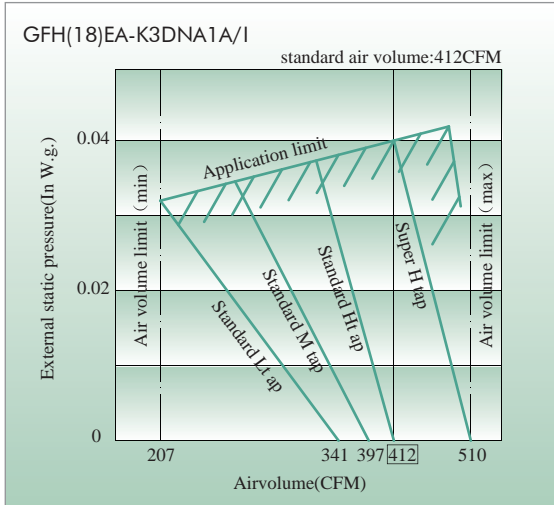
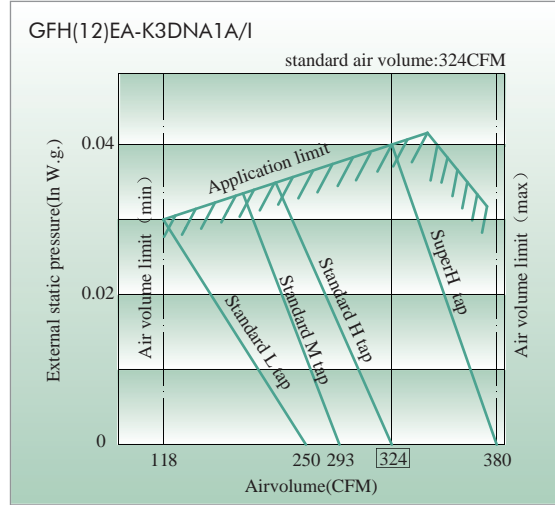
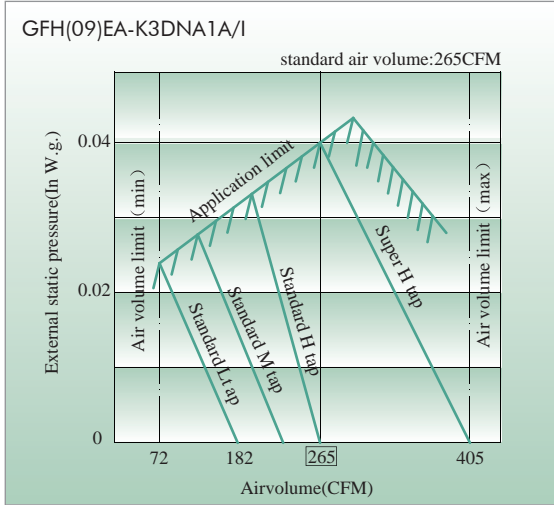

# 10 DIMENSIONAL DRAWINGS

## ➔ 10.1 Indoor Unit

### ◆ VIOLA

Dimensions for: GWH(07)RA-K3DNA3E/I, GWH(09)RA-K3DNA3E/I, GWH(12)RB-K3DNA3E/I, GWH(18)RC-K3DNA3E/I

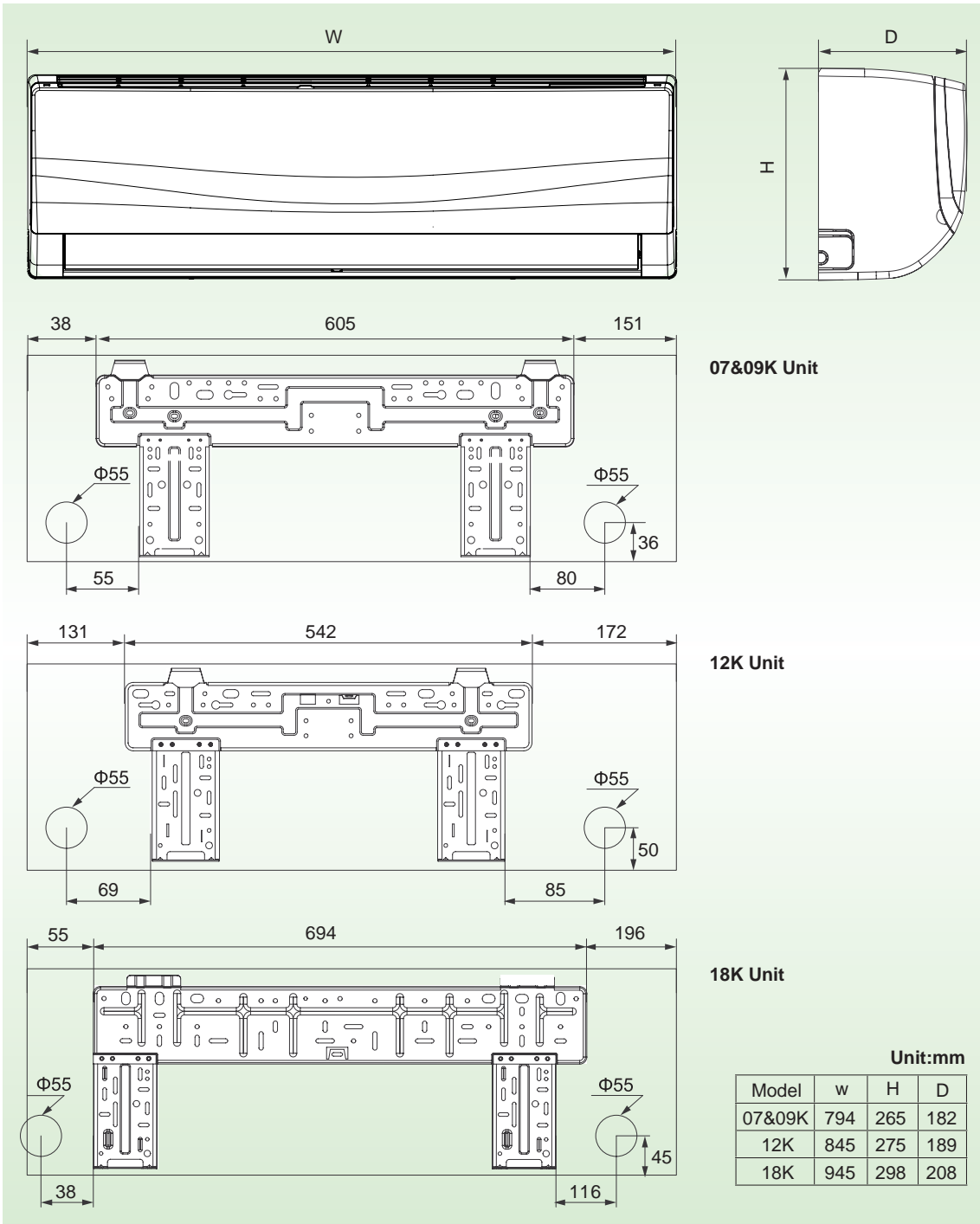

## ◆ Change

Dimensions for:GWH(07)KF-K3DNA6E/I, GWH(09)KF-K3DNA6E/I, GWH(12)KF-K3DNA6E/I, GWH(18)KG-K3DNA6E/II

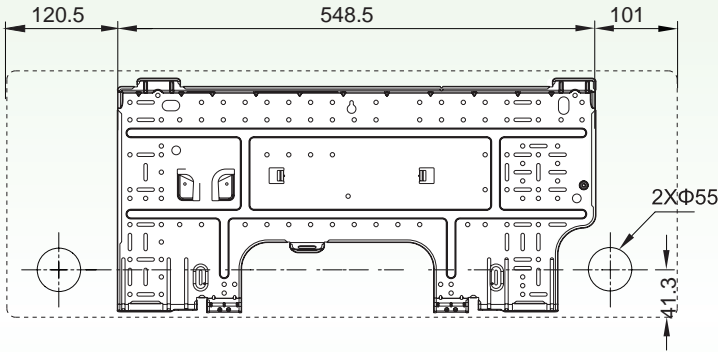
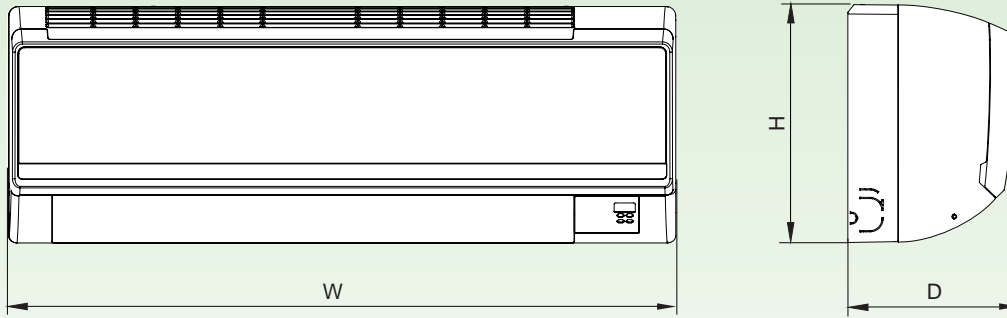

07/09/12K unit

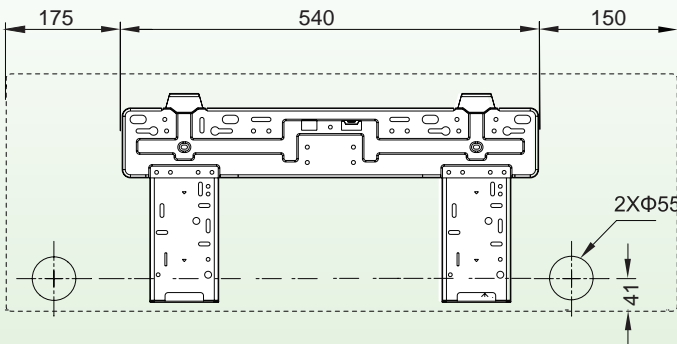

18K unit

unit:mm

Modle	W	H	D
07/09/12K	770	283	201
18K	865	305	215

◆ Cozy

Dimensions for: GWH(07)MA-K3DNA4E/I, GWH(09)MA-K3DNA4E/I, GWH(12)MB-K3DNA4E/I, GWH(18)MC-K3DNA4E/I

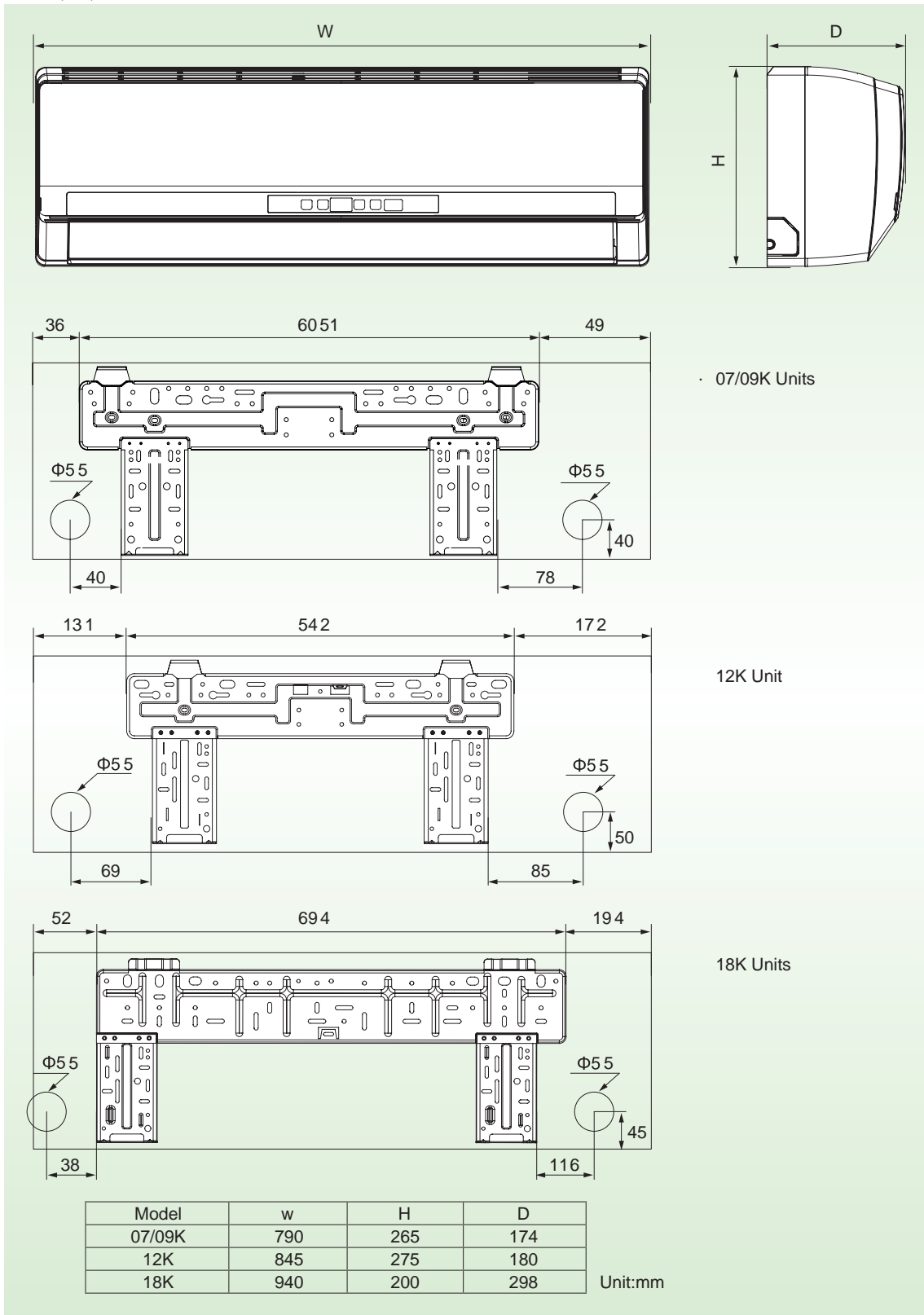

## ◆ Duct Type

Dimensions for:GFH(09)EA-K3DNA1A/I,GFH(12)EA-K3DNA1A/I,GFH(18)EA-K3DNA1A/I,GFH(21)EA-K3DNA1A/I,GFH(24)EA-K3DNA1A/I

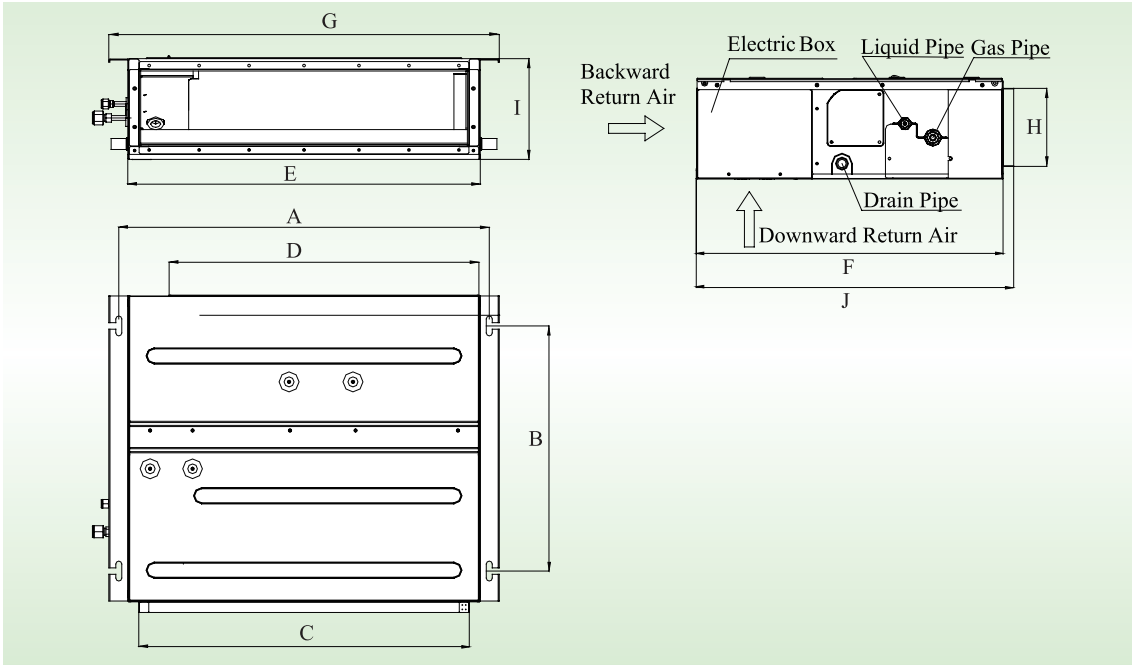

Model \ Item	A	B	C	D	E	F	G	H	I	J
GFH(09)EA-K3DNA1A/I	742	491	662	620	700	615	782	156	200	635
GFH(12)EA-K3DNA1A/I	942	491	862	820	900	615	982	156	200	635
GFH(21)EA-K3DNA1A/I	1142	491	1062	1020	1100	615	1182	156	200	635
GFH(24)EA-K3DNA1A/I										

### NOTES:

Be sure to place a inspection opening at the position indicated in the following figure for maintenance of the equipment.

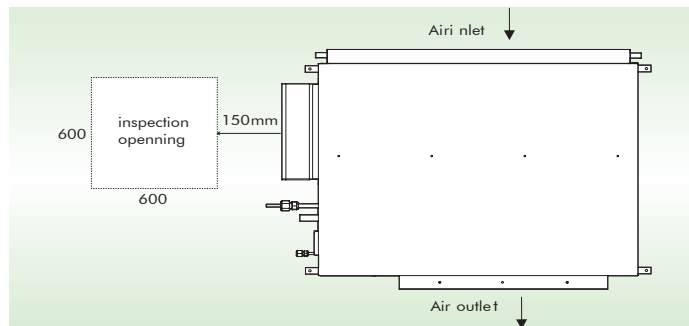

### ◆ Cassette Type

Dimensions for:GKH(12)BA-K3DNA1A/I,GKH(18)BA-K3DNA1A/I,GKH(24)BA-K3DNA1A/I

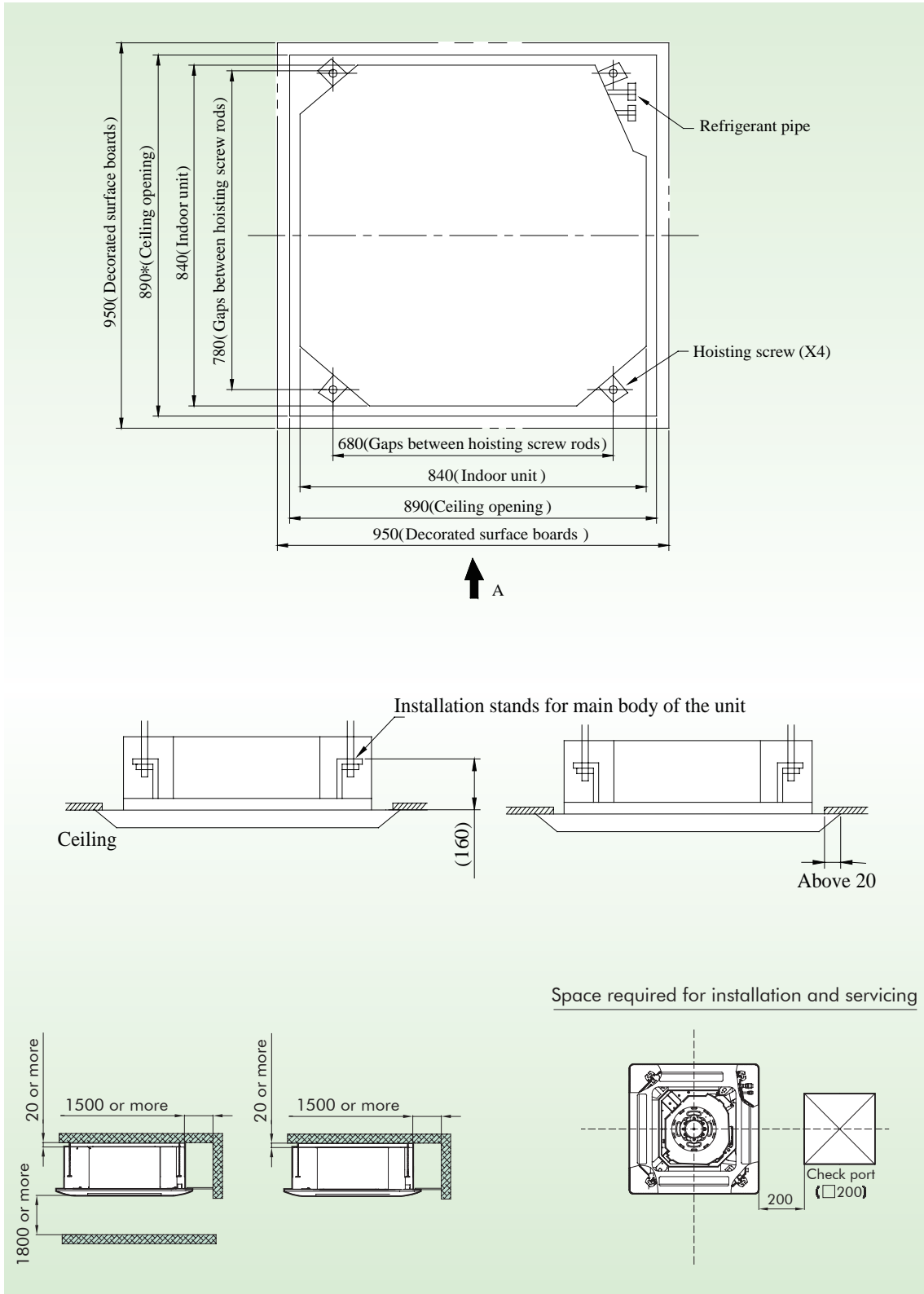

Dimensions for:GKH(12)BA-K3DNA2A/I;GKH(18)BA-K3DNA2A/I

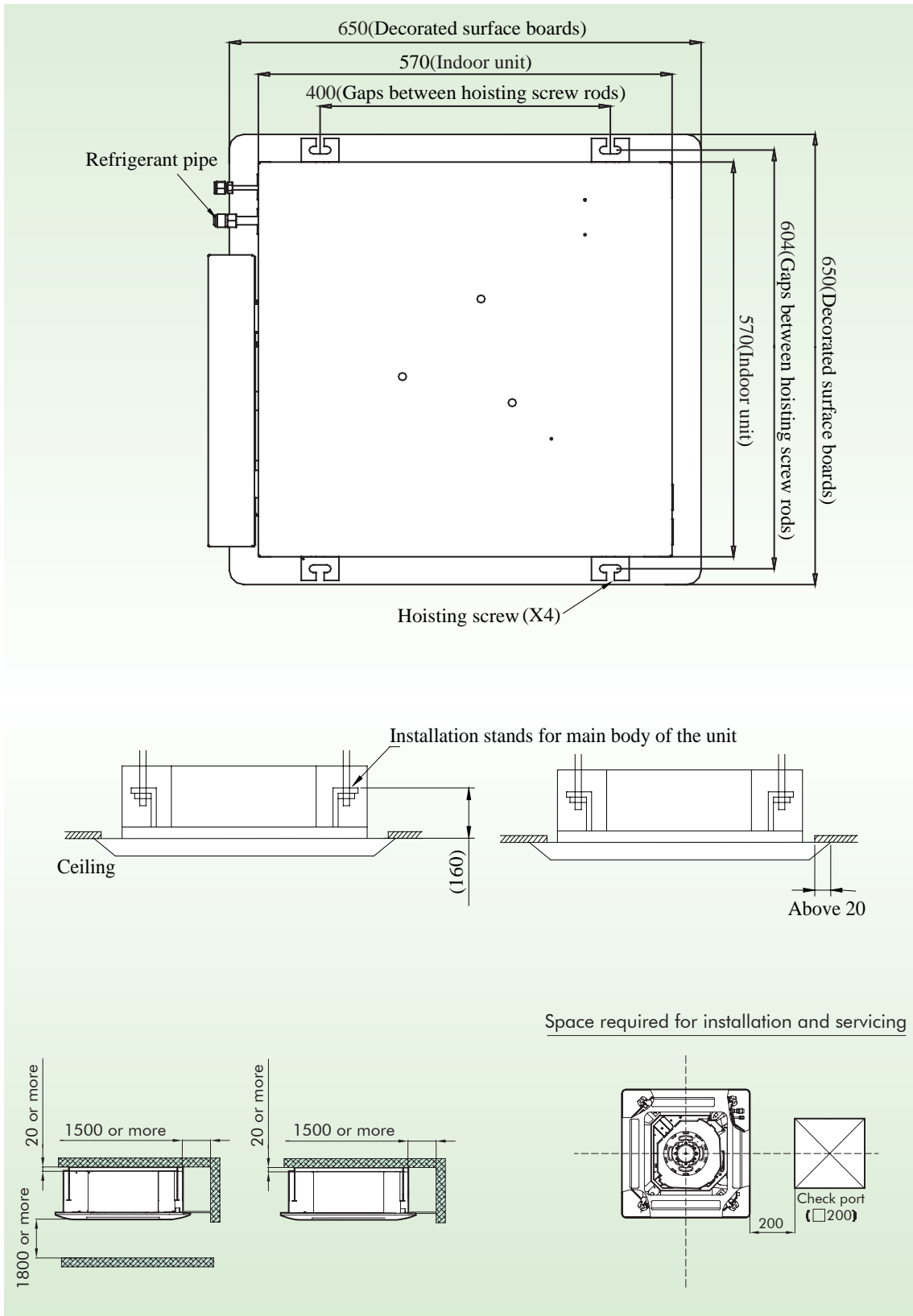

◆ **Floor Ceiling Type**

Dimensions for: GTH(09)BA-K3DNA1A/I, GTH(12)BA-K3DNA1A/I, GTH(18)BA-K3DNA1A/I, GTH(24)BA-K3DNA1A/I

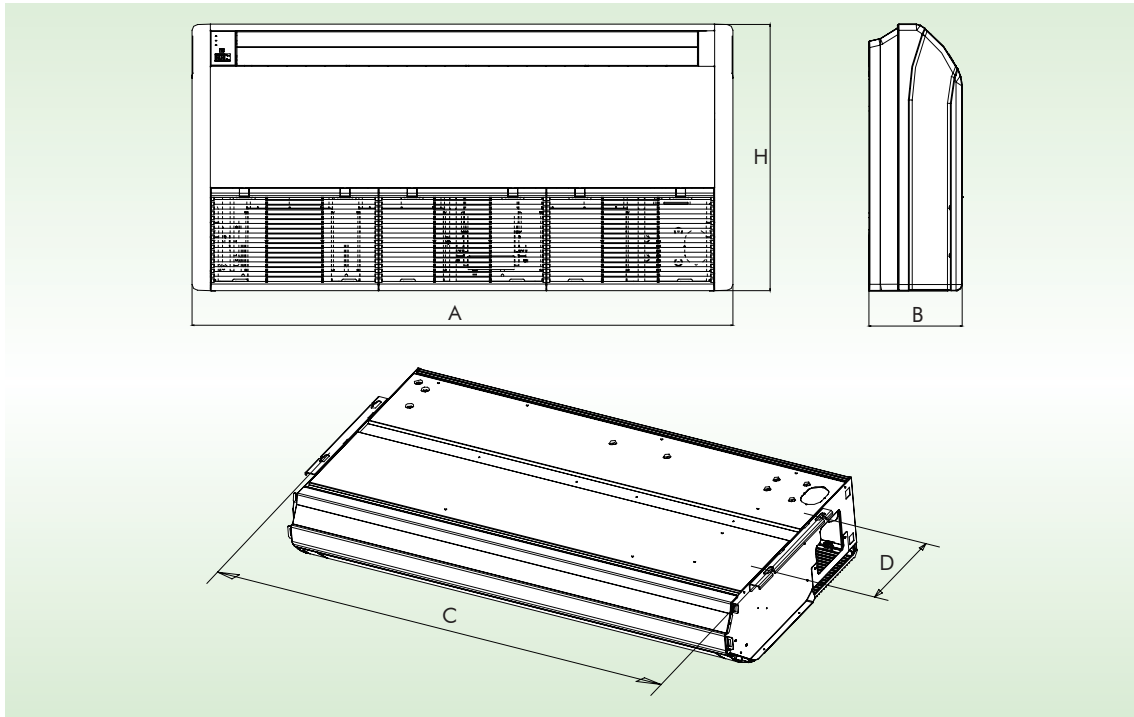

Model	A	B	H	C	D
GTH(09)BA-K3DNA1A/I	1220	225	700	1158	280
GTH(12)BA-K3DNA1A/I					
GTH(18)BA-K3DNA1A/I					
GTH(24)BA-K3DNA1A/I					

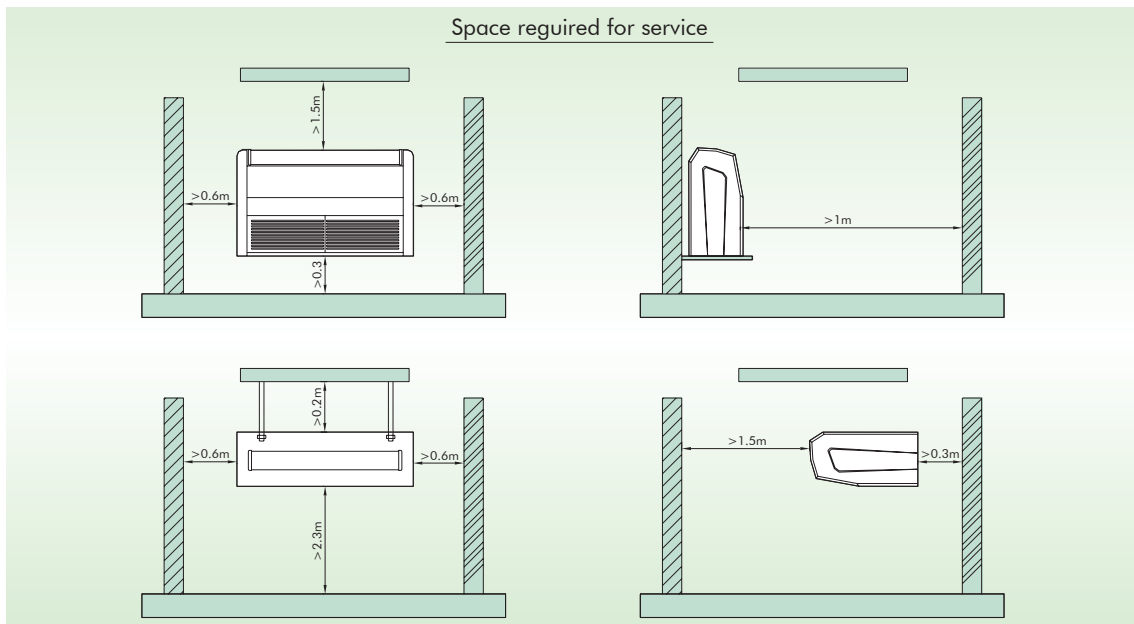



## ➔ 10.2 Outdoor Unit

Dimensions for: GWHD(18)NK3FO

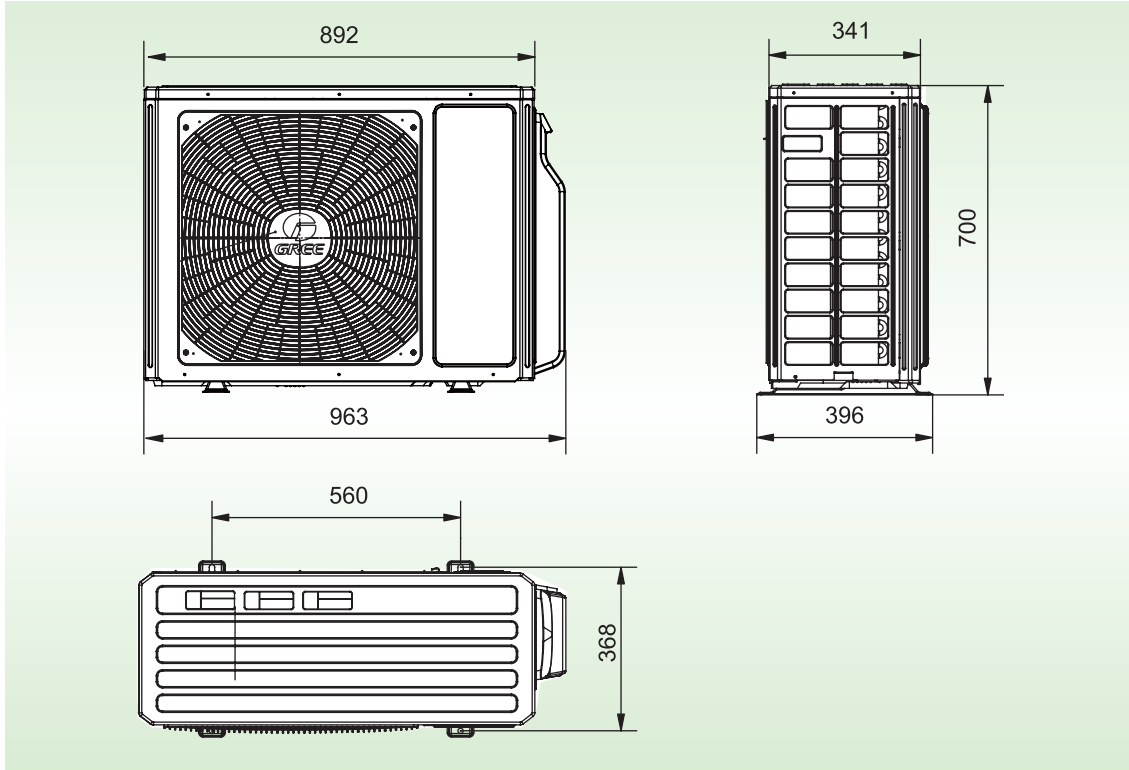

Dimensions for: GWHD(24)NK3FO, GWHD(24)NK3GO, GWHD(28)NK3FO

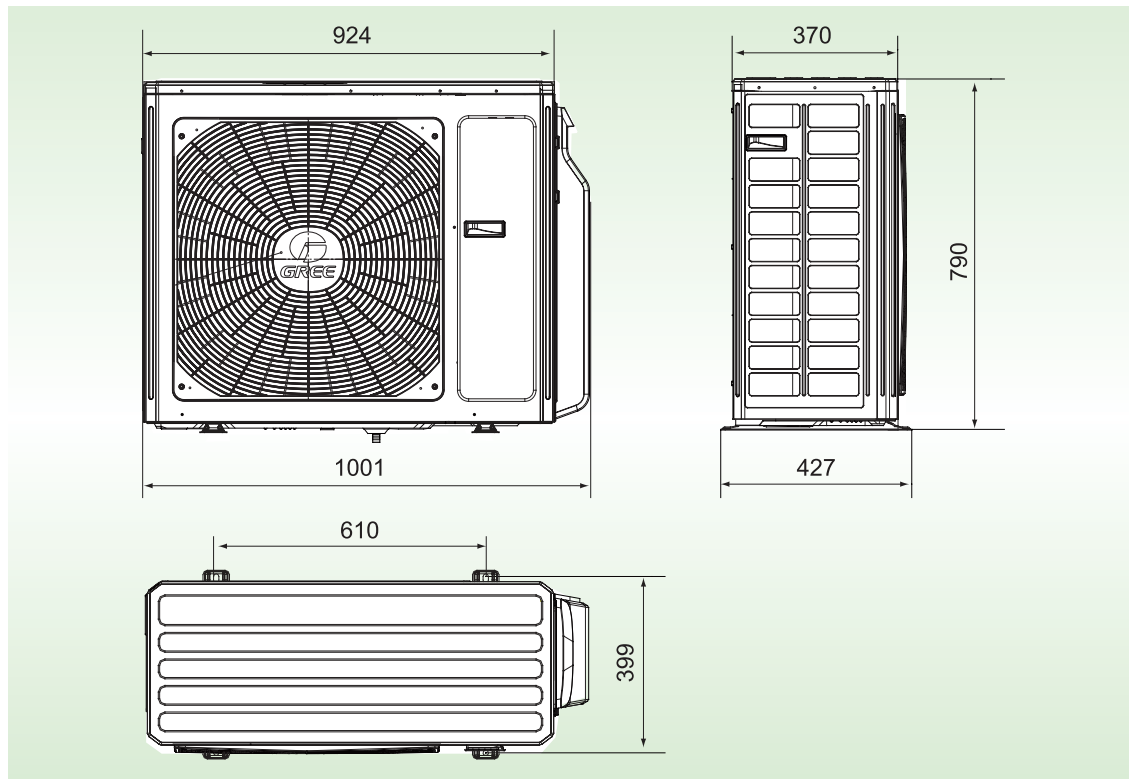

Dimensions for:GWHD(36)NK3BO

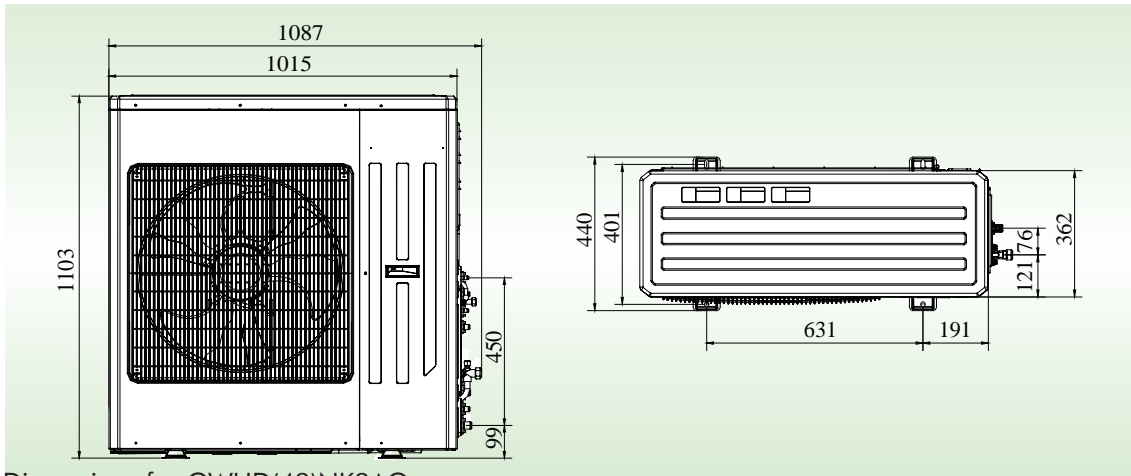

Dimensions for:GWHD(42)NK3AO

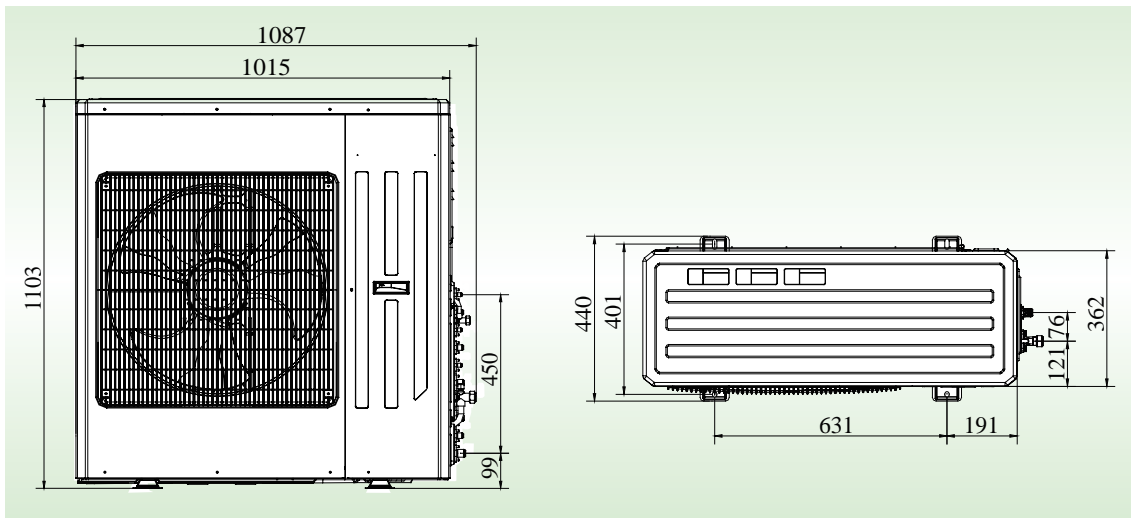

During installation, tighten the support and base of the unit by using M12 screws.  
 Outdoor unit shall be installed on a concrete base 10cm high.  
 Space dimension for installation of the unit is shown below.

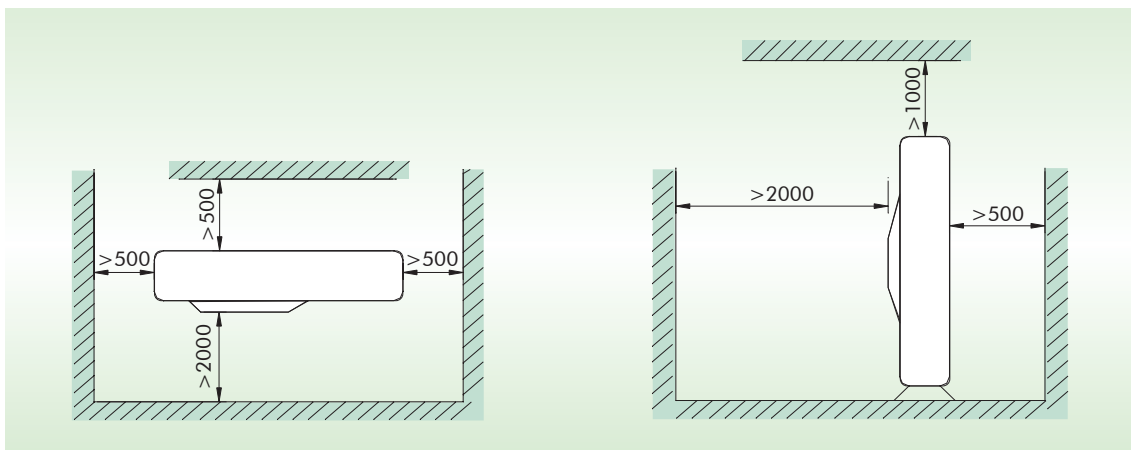

## ➔ 10.3 Controller

### ◆ Wired Remote Controller

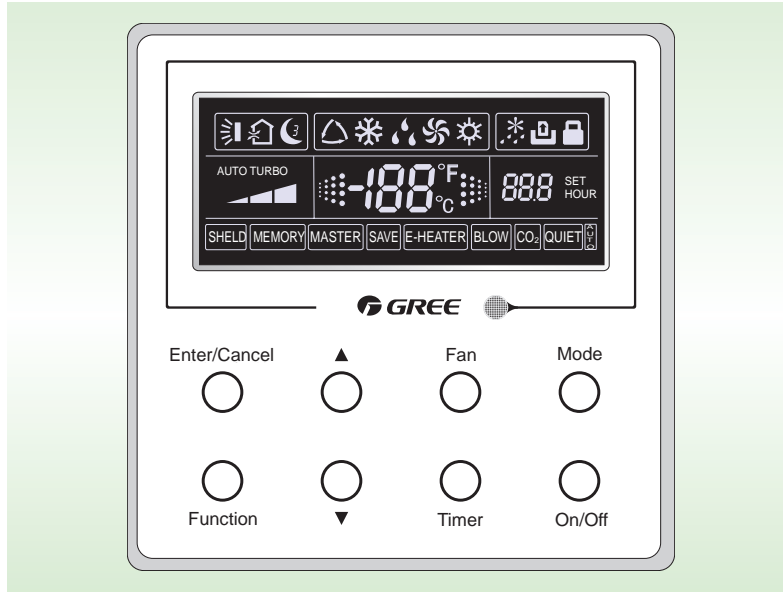

### ◆ Wireless Remote Controller



Gree Electric Appliance, Inc. of Zhuhai, founded in 1991, is the world's largest air conditioner enterprise integrating R&D, manufacturing, marketing and services. Technology Innovation and quality are always our priority. With efforts of thousands of Gree's engineers, we own more than 3500 patents for our products. Nowadays, we have 7 production bases in Zhuhai, Chongqing, Hefei and Zhengzhou(China), as well as Brazil, Pakistan and Vietnam, with annual production capacity of 30 million sets of residential air conditioners and 4 million sets of commercial air conditioners.

With the installation of Gree commercial air conditioners in important projects at home and abroad like Media Village for 2008 Beijing Olympic Games, Stadiums for 2010 World Cup in South Africa, as well as India Telecom base station, Gree commercial air conditioners are ready to develop steadily to every corner in the world, to present a more comfortable and harmonious working environment and family atmosphere.



GREE MAKING BETTER AIR CONDITIONERS GREE MAKING BETTER AIR CONDITIONERS GREE MAKING BETTER AIR CONDITIONERS



Add: West Jinji Rd, Qianshan Zhuhai, Guangdong, China 519070

Tel: (+86-756)8614883 Fax: (+86-756)8614998

Http://www.gree.com Email: gree@gree.com.cn

For continuous improvement in the products, Gree reserves the right to modify the product specification and appearance in this manual without notice and without incurring and obligations.

■ SJ00400179